

METRICA

MADE TO MEASURE



ARTICOLI PROMOZIONALI

PROMOTIONAL ITEMS
ARTICLES PROMOTIONNELS
WERBEARTIKEL
ARTÍCULOS DE PROMOCIÓN

HOW TO READ

COME LEGGERE - COMMENT LIRE - LESEAWLEITUNG - CÓMO LEER

Ref.

CODICE PRODOTTO

Product code - Code produit - Produktcode - Código producto

A

A x B



MISURE NASTRI / RIGHE / METRI / CALIBRI

Tape measurements / rulers / calipers - Ruban de mesure / règles / jauges - Maßbänder / Lineale / Lehren - Cintas métricas / reglas / calibres



CODICE A BARRE PRODOTTO

Product barcode - Code-barres du produit - Barcode des Produkts - Código de barras del producto



MINIMO IMBALLO

Minimum packaging - Emballage minimum - Mindestmenge - Embalaje mínimo

LxHxP

L

H x L



MISURE PRODOTTO

Product measurements - Mesures du produit - Produktabmessungen - Medidas del producto

INFORMAZIONI PER LA STAMPA

Printing information - Informations pour l'impression - Informationen für den Druck - Información de impresión

H x L

10 x 30 mm

Stampa su etichetta in quadricromia
Four-colour label printing - Impression en quadrichromie sur étiquettes - Vierfarbendruck auf Etiketten - Impresión de la etiqueta en cuatricromía

oppure - or - ou - oder - o

Stampa diretta massimo 1 colore
- Direct printing maximum 1 color - Impression directe en 1 couleur maximum - Direktdruck maximal 1 Farbe - Impresión directa a 1 color como máximo

Ø

39 mm

Stampa su etichetta in quadricromia
Four-colour label printing - Impression en quadrichromie sur étiquettes - Vierfarbendruck auf Etiketten - Impresión de la etiqueta en cuatricromía

H x L

27 x 160 mm
27 x 160 mm

Stampa su fianco
Print on side
Impression sur le côté - Druck auf der Seite - Impresión lateral

H x L

—
6 x 160 mm

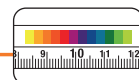

Stampa su stecca - Print on fold - Impression sur branche - Druck auf Anfangsglied - Impresión sobre varilla

METODI DI PERSONALIZZAZIONE

Customization methods - Méthodes de personnalisation - Personalisierungsmethoden - Métodos de personalización



*STAMPA DIRETTA

Direct printing - Impression directe - Direktdruck - Impresión directa

STAMPA SU ETICHETTA IN QUADRICROMIA

Four-colour label printing - Impression en quadrichromie sur étiquettes - Vierfarbendruck auf Etiketten - Impresión de la etiqueta en cuatricromía



STAMPA LASER

Laser printing - Impresión láser - Laserdruck - Impresión laser

*Nel caso di stampa diretta con colore a pantone, possibile maggiorazione costo stampa calcolato in fase di preventivo - In case of direct printing with Pantone colors, the printing may can increase - En el caso de la impresión directa con colores Pantone, los costos de impresión pueden aumentar. - En cas d'impression directe avec couleurs Pantone, les coûts d'impression peuvent augmenter - Im Fall des Direktdruckes mit Pantone-Farben, können die Druckkosten höher ausfallen.
Nel corso di validità del presente catalogo, i prodotti potrebbero subire modifiche, rispetto alle immagini proposte, che non ne compromettono l'utilizzo o le caratteristiche tecniche. Metrica si riserva la facoltà di apportare modifiche senza obbligo di preavviso. - Modifications and errors excepted. All models are shown for information only. Metrica has the right to do any changes without any previous advise. - Sous réserve de modifications et d'erreurs d'impression. Tous les modèles sont montrés à titre informatif. Metrica se réserve la faculté d'apporter tout changement sans avis préalable. - Änderungen und Fehler vorbehalten. Die abgebildeten Produkte werden nur zur Informationszwecken dargestellt. Metrica ist berechtigt, Änderungen ohne vorherige Benachrichtigung vorzunehmen. - Salvo modificaciones y errores. Todos los artículos son mostrados solo a título informativo. Metrica puede hacer modificaciones sin aviso previo.

FLESSOMETRI - 4

TAPE RULES - MÈTRES À RUBAN - ROLLBANDMASSE - FLEXÓMETROS

METRI - 21

FOLDING RULES - MÈTRES PLIANTS - MASSSTÄBE - METROS

BRAVO LASER - 28

METRI PER SARTO - INCLINOMETRO - 37

TAYLOR'S TAPES - MÈTRES DE COUTURIER - SCHNEIDERMASSBÄNDER - METROS PARA SASTRE
INCLINOMETER - INCLINOMÈTRE - NEIGUNGSWASSERWAAGE - INCLINÓMETRO

CUTTER - 38

CUTTERS - CATTERX - MESSER - CÚTERES

MATITE SPECIALI - 48

SPECIAL PENCILS - CRAYONS SPÉCIAUX - SPEZIALBLEISTIFTE - LÁPICES ESPECIALES

MATITE IN LEGNO - 50

SPECIAL PENCILS - CRAYONS EN BOIS - HOLZBLEISTIFTE - LÁPICES DE MADERA

LIVELLE - 54

LEVELS - NIVEAUX - WASSERWAAGEN - NIVELES

ROTELLE - 57

LONG TAPE RULES - MESURES LONGUES - RAHMENBANDMASSE - CINTAS MÉTRICAS

CALIBRI - 58

CALIPERS - PIEDS À COULISSE - MESSSCHIEBER - CALIBRES

LENTI D'INGRANDIMENTO - 60

LENS - LOUPES - LUPEN - LUPAS

PORTACHIAVI - 62

KEY-HOLDERS - PORTE-CLÉS - SCHLÜSSELANHÄNGER - LLAVEROS

CALIBRI BATTISTRADA - 67

TYRE GAUGES - JAUGES PNEUS - REIFENPROFILMESSER - MEDIDORES NEUMÁTICOS

RIGHE - RIGHELLI - 69

RULES - RÈGLES - MASSSTÄBE - LINEALE - REGLAS

FINGERSAFE - 74

DISTANZIOMETRI - 75

LASERDISTANCE METERS - DISTANCÉMÈTRES LASER - LASER-DISTANZMESSGERÄTE - MEDIDORES DE DISTANCIALÁSER

REVERXO

Flessometro **autobloccante**, gancio a **doppia presa**
Self-locking tape rule, **double-grip** hook
 Mètre à ruban **autobloquant**, crochet à **double**
Selbstblockierendes Bandmaß mit **Doppelgriffhaken**
 Flexòmetro **autobloquanté** con gancho **doble**



CE II

Ref.			
98103	3 m x 16 mm	8001066981038	12
98104	5 m x 19 mm	8001066981045	12
98105	5 m x 25 mm	8001066981052	6
98108	8 m x 25 mm	8001066981083	6

H x L

44 x 21 mm *Stampa su etichetta in quadricromia*
 50 x 25 mm *Four-colour label printing - Impression en quadrichromie sur*
 50 x 25 mm *étiquettes - Vierfarbendruck auf Etiketten - Impresión de la*
 60 x 30 mm *etiqueta en cuatricromía*

FLASH TOUCH

Flessometro con **cassa antiscivolo bimeriale** giallo fluorescente
 Tape rule with fluorescent yellow **bimaterial anti-slip case**
 Mètre à ruban avec **boîtier antidérapant en bimatériel** jaune fluorescent
 Rollbandmaß mit fluoreszierendem, gelbem, **rutschfestem Gehäuse aus Bimaterial**
 Cinta con **estuche antideslizante bimeriale** amarillo fluorescente

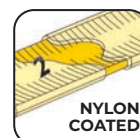

CE II

Ref.			
98963	3 m x 16 mm	8001066989638	12
98964	5 m x 19 mm	8001066989645	12
98965	5 m x 25 mm	8001066989652	6
98968	8 m x 25 mm	8001066989683	6

Ø

36 mm *Stampa su etichetta in quadricromia*
 42 mm *Four-colour label printing - Impression en quadrichromie sur*
 42 mm *étiquettes - Vierfarbendruck auf Etiketten - Impresión de la*
 49 mm *etiqueta en cuatricromía*

NEW



OTHER MODELS

BICOLOR



BICOLOR

Flessometro con cassa bimateriale antiscivolo, **nastro con cambio colore ogni 10 cm per i primi 2 metri**



Tape rule with material non-slip case, **tape with colour change every 10 cm for the first 2 metres**

Mètre à ruban avec boîtier antidérapant en bimatériel, **ruban avec changement de couleur tous les 10 cm sur les 2 premiers mètres**

Rollbandmaß mit rutschfestem Gehäuse aus Bimaterial, **Band mit Farbwechsel alle 10 cm auf den ersten 2 Metern**

Cinta con revestimiento antideslizante bimaterial, **cinta con cambio de color cada 10 cm durante los 2 primeros metros**



Ref.			
98220	3 m x 19 mm	8001066982202	12
98221	5 m x 22 mm	8001066982219	12
98222	5 m x 28 mm	8001066982226	6
98223	8 m x 28 mm	8001066982233	6

Ø

34 mm **Stampa su etichetta in quadricromia**
 37 mm *Four-colour label printing - Impression en quadrichromie sur*
 37 mm *étiquettes - Vierfarbendruck auf Etiketten - Impresión de la*
 47 mm *etiqueta en cuatricromía*

MAGNETE FORTE

Flessometro con **magnete e cassa antiscivolo**

Tape rule with **magnet and non-slip case**

Mètre à ruban avec **aimant et boîtier antidérapant**

Rollbandmaß mit **Magnet und rutschfestem Gehäuse**

Cinta con **imán y funda antideslizante**

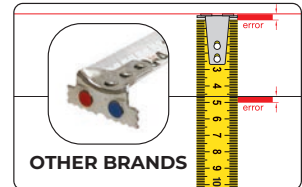
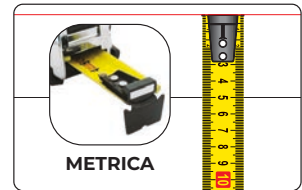
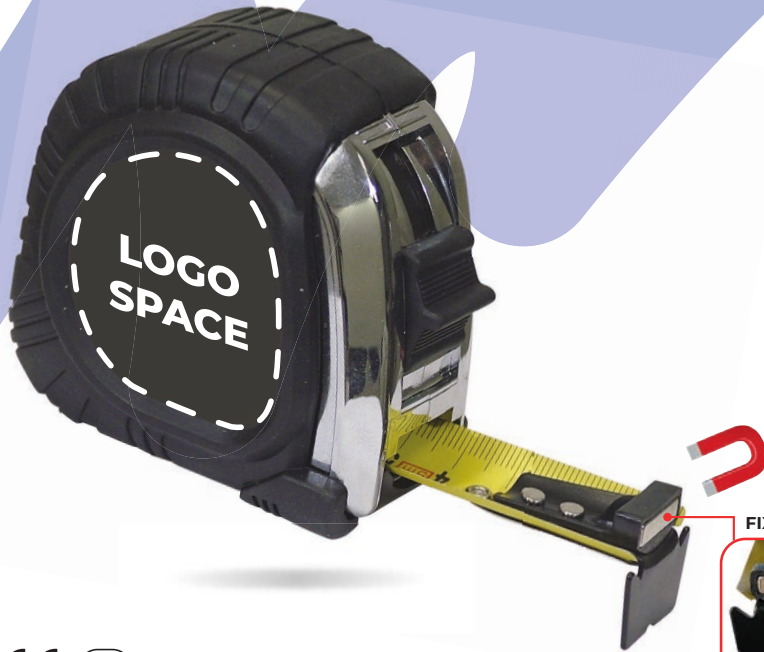

CE II

Ref.				H x L	<p>Stampa su etichetta in quadricromia <i>Four-colour label printing - Impression en quadrichromie sur étiquettes - Vierfarbendruck auf Etiketten - Impresión de la etiqueta en cuatricromía</i></p>
98597	5 m x 25 mm	8001066985975	6	43 x 40 mm	

METRICA FLASH

Flessometro con **nastro fluorescente (fronte), doppia graduazione**, cassa bimateriale

Fluorescent tape (front), double graduation, bi material case

Ruban fluorescent (sur le recto), double graduation, Boîtier bi-matière

Fluoreszierendes Band (Vordersite), Doppelte Teilung, Bi-Material-Kapsel

Cinta fluorescente (fronte), doble graduación, estuche bi-material

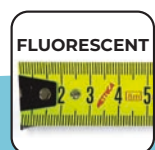
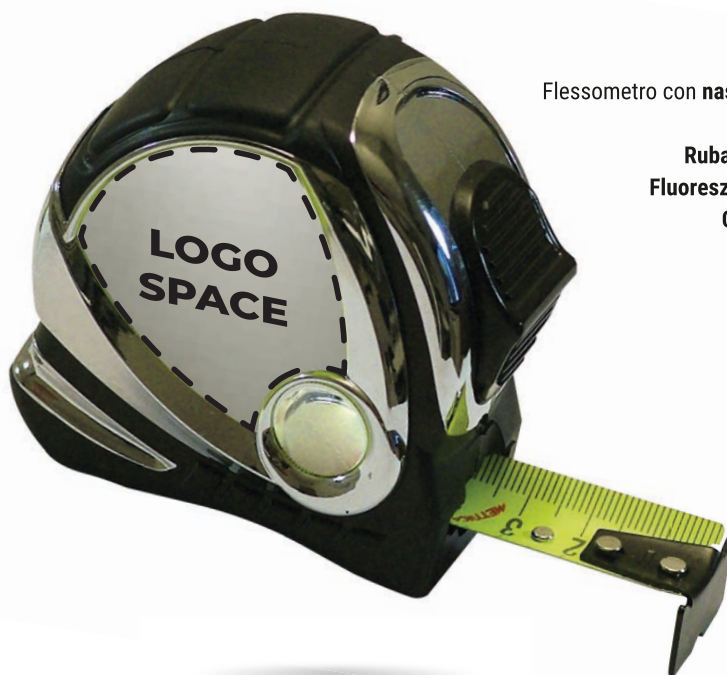

CE II

Ref.				H x L	<p>Stampa su etichetta in quadricromia <i>Four-colour label printing - Impression en quadrichromie sur étiquettes - Vierfarbendruck auf Etiketten - Impresión de la etiqueta en cuatricromía</i></p>
98973	3 m x 16 mm	8001066989737	6	38 x 38 mm	
98974	3 m x 19 mm	8001066989744	6	44 x 44 mm	
98975	5 m x 25 mm	8001066989751	6	44 x 44 mm	
98978	8 m x 25 mm	8001066989782	6	52 x 52 mm	



33 mm



XL 33

Flessometro con **nastro 33 mm** speciale gancio con **gomma antiscivolo**

Tape 33 mm wide; exclusive hook with **non-slip rubber**

Ruban large 33 mm; crochet revêtu en **caoutchouc antiglisement**

Bandbreite 33 mm; Spezial-Haken mit **Anti-Rutsch-Gummi**

Cinta de 33 mm de ancho; gancho revestido en **caucho antideslizante**



CE II

Ref.					<p>Stampa su etichetta in quadricromia <i>Four-colour label printing - Impression en quadrichromie sur étiquettes - Vierfarbendruck auf Etiketten - Impresión de la etiqueta en cuatricromía</i></p>
98755	5 m x 33 mm	8001066987559	1	40 mm	

ALL BLACK TAPE

Flessometro nero a **doppia graduazione**, **cassa gommata**, **nastro nero**, **autobloccante**, **testurizzato**
 Black tape, **double-graduation**, **rubberized case**, **black tape**, **self-locking**, **textured**
 Mètre à ruban noir à **double graduation**, **boîtier caoutchouté**, **ruban noir**, **autobloquant**, **texturé**
 Schwarzes Bandmaß mit **Doppelteilung**, **gummiertes Gehäuse**, **schwarzes Band**, **selbstblockierend**, **texturiert**
 Flexómetro negro, **doble graduación**, **funda engomada**, **cinta negra**, **autoblocante**, **texturizada**



CE II

Ref.				Ø	
98143D	3 m x 19 mm	8001066981434	12	39 mm	Stampa su etichetta in quadricromia
98145D	5 m x 25 mm	8001066981458	6	39 mm	<i>Four-colour label printing - Impression en quadrichromie sur étiquettes - Vierfarbendruck auf Etiketten - Impresión de la etiqueta en cuatricromía</i>
98148D	8 m x 25 mm	8001066981489	6	46 mm	



SELF LOCKING

Flessometro con nastro bianco **autobloccante**, **numeri giganti**, **cassa gommata**
Self-locking tape rule, **giant numbers**, **rubberised case**
 Mètre à ruban **autobloquant**, **chiffres géants**, **étui caoutchouté**
Selbstblockierendes Bandmaß, **große Zahlen**, **gummiertes Gehäuse**
 Flexómetro con cinta blanca **autobloqueante**, **números gigantes**, **estuche engomado**

GIANT NUMBERS



OTHER MODELS



CE II

Ref.				H x L	
98593	3 m x 16 mm	8001066985937	12	43 x 31 mm	Stampa su etichetta in quadricromia
98595	5 m x 19 mm	8001066985951	12	48 x 40 mm	<i>Four-colour label printing - Impression en quadrichromie sur étiquettes - Vierfarbendruck auf Etiketten - Impresión de la etiqueta en cuatricromía</i>
98596	5 m x 25 mm	8001066985968	6	48 x 40 mm	
98598	8 m x 25 mm	8001066985982	6	56 x 47 mm	
98599	10 m x 25 mm	8001066985999	6	57 x 47 mm	



METRICA ACTION CHROMED

Flessometro con **nastro autobloccante a doppia graduazione, magnete fisso** e cassa cromata
 Tape rule with **self-locking double graduation tape, fixed magnet** and chrome-plated case
 Mètre ruban **double graduation autobloquant, aimant fixe** et boîtier chromé
 Selbstblockierendes Band mit **Doppelteilung, feststehendem Magnet** und verchromtes Gehäuse
 Flexómetro **autobloqueante con doble graduación, imán fijo** y estuche cromado

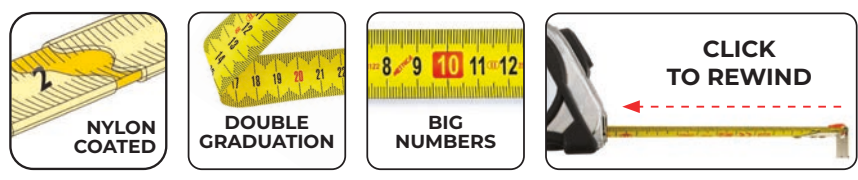

Ref.				H x L	
98212	3 m x 16 mm	8001066982127	6	45 x 45 mm	Stampa su etichetta in quadricromia
98214	5 m x 19 mm	8001066982141	6	51 x 51 mm	Four-colour label printing - Impression en quadrichromie sur étiquettes - Vierfarbendruck auf Etiketten - Impresión de la etiqueta en cuatricromía
98215	5 m x 25 mm	8001066982158	6	51 x 51 mm	
98218	8 m x 25 mm	8001066982189	6	58 x 58 mm	

3 STOP RED MODEL G

Flessometro con cassa bimateriale, **3 bottoni di bloccaggio**

Bimaterial case, **3 stop buttons**



Boîtier en bi-matière, **3 boutons de blocage**

Kapsel aus Bi-Material, **3 Blockierknöpfe**

Estuche de bi-material, **3 botones de bloqueo**



CE II

Ref.				H x L	
98643G	3 m x 16 mm	8001066986439	12	24 x 36 mm	Stampa su etichetta in quadricromia
98645G	5 m x 19 mm	8001066986453	12	28 x 40 mm	<i>Four-colour label printing - Impression en quadrichromie sur étiquettes - Vierfarbendruck auf Etiketten - Impresión de la etiqueta en cuatricromía</i>
98648G	8 m x 25 mm	8001066986484	6	35 x 47 mm	

3 STOP YELLOW MODEL BF

Flessometro con cassa bimateriale, **3 bottoni di bloccaggio**

Bimaterial case, **3 stop buttons**



Boîtier en bi-matière, **3 boutons de blocage**

Kapsel aus Bi-Material, **3 Blockierknöpfe**

Estuche de bi-material, **3 botones de bloqueo**



CE II

Ref.				H x L	
98653BF	3 m x 16 mm	8001066986538	12	24 x 32 mm	Stampa su etichetta in quadricromia
98656BF	5 m x 25 mm	8001066986569	6	42 x 40 mm	<i>Four-colour label printing - Impression en quadrichromie sur étiquettes - Vierfarbendruck auf Etiketten - Impresión de la etiqueta en cuatricromía</i>
98658BF	8 m x 25 mm	8001066986583	6	44 x 46 mm	

NEW





3 STOP MODEL NH

Flessometro con cassa bimateriale, **3 bottoni di bloccaggio**
 Bimaterial case, **3 stop buttons**
 Boîtier en bi-matiere, **3 boutons de blocage**
 Kapsel aus Bi-Material, **3 Blockierknöpfe**
 Estuche de bi-material, **3 botones de bloqueo**





CE II

Ref.				H x L	
98643NH	3 m x 16 mm	8001066986439	12	35 x 35 mm	Stampa su etichetta in quadricromia <i>Four-colour label printing - Impression en quadrichromie sur étiquettes - Vierfarbendruck auf Etiketten - Impresión de la etiqueta en cuatricromía</i>
98645NH	5 m x 19 mm	8001066986453	12	40 x 40 mm	
98646NH	5 m x 25 mm	8001066986460	6	40 x 40 mm	
98648NH	8 m x 25 mm	8001066986484	6	44 x 45 mm	
98650NH	10 m x 25 mm	8001066986507	6	50 x 50 mm	



CE II

Ref.				H x L	
98653NH	3 m x 16 mm	8001066986538	12	35 x 35 mm	Stampa su etichetta in quadricromia <i>Four-colour label printing - Impression en quadrichromie sur étiquettes - Vierfarbendruck auf Etiketten - Impresión de la etiqueta en cuatricromía</i>
98655NH	5 m x 19 mm	8001066986552	12	40 x 40 mm	
98656NH	5 m x 25 mm	8001066986569	6	40 x 40 mm	
98658NH	8 m x 25 mm	8001066986583	6	44 x 45 mm	
98660NH	10 m x 25 mm	8001066986606	6	50 x 50 mm	

LOOK

Cassa bimateriale, **finestra di lettura per misure interne**
 Bimaterial case, **window for inside measure reading**
 Boîtier en bi-matériel, **fenêtre pour lecture mesures intérieures**
 Kapsel aus Bi-Material, **Sichtfenster für Innenmessungen**
 Estuche de bi-material, **lectura para medidas interiores**

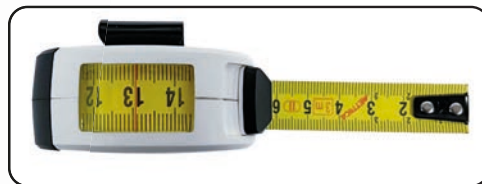

CE II

Ref.				\emptyset	<p>41 mm</p> <p>Stampa su etichetta in quadricromia <i>Four-colour label printing - Impression en quadrichromie sur étiquettes - Vierfarbendruck auf Etiketten - Impresión de la etiqueta en cuatricromía</i> oppure - or - ou - oder - o</p> <p>Stampa diretta massimo 1 colore - Direct printing maximum 1 color - Impression directe en 1 couleur maximum - Direktdruck maximal 1 Farbe - Impresión directa a 1 color como máximo</p>
98264	3 m x 16 mm	8001066982646	6		

JUST IN

Finestra di lettura per **misure interne**
 Window for **inside measure** reading
 Fenêtre pour lecture **mesures intérieures**
 Sichtfenster für **Innenmessungen**
 Lectura para **medidas interiores**



CE II

Ref.				H x L	<p>56 x 61 mm</p> <p>Stampa su etichetta in quadricromia <i>Four-colour label printing - Impression en quadrichromie sur étiquettes - Vierfarbendruck auf Etiketten - Impresión de la etiqueta en cuatricromía</i></p>
98206	5 m x 19 mm	8001066982066	6		

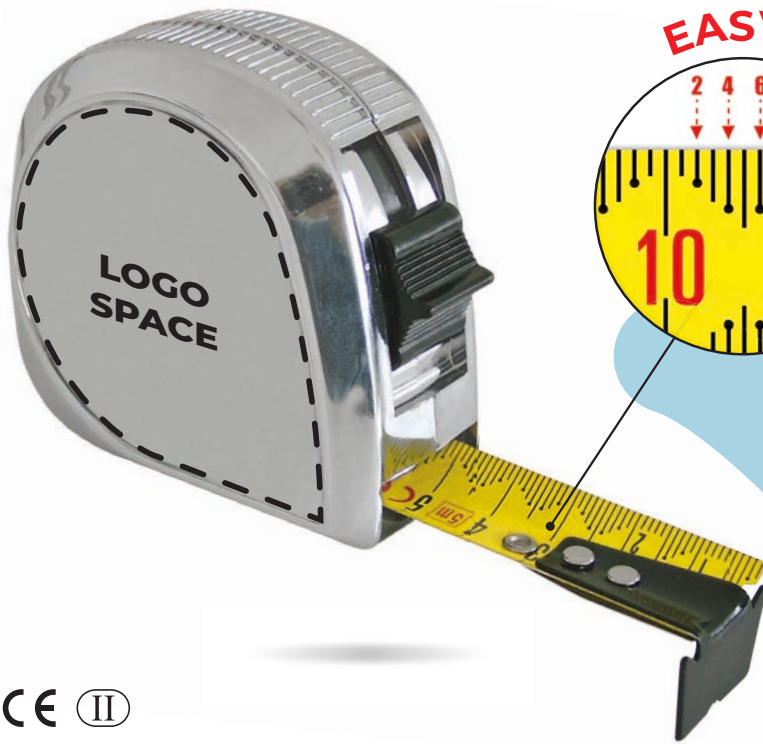

EASY READING

Flessometro con **graduazione a lettura facilitata**
 Tape rule with **graduation for easy reading**
 Mètre à ruban avec **graduación pour lecture facilitée**
 Rollbandmaß mit **Teilung für vereinfachtes Ablesen**
 Flexómetro con **graduación a lectura simplificada**

CE II



EASY READING



OTHER MODELS

Ref.				H x L
98665	5 m x 25 mm	8001066986651	6	54 x 56 mm <i>Stampa su etichetta in quadricromia</i> <i>Four-colour label printing - Impression en quadrichromie sur étiquettes - Vierfarbendruck auf Etiketten - Impresión de la etiqueta en cuatricromía</i>



CHROME CASE DROP SHAPE

Cassa cromata
 Chromed case
 Boîtier chromé
 Verchromte Kapsel
 Estuche cromado

CE II



Ref.				H x L
98433	3 m x 19 mm	8001066984336	6	47 x 49 mm
98396	3 m x 25 mm	8001066983964	6	54 x 56 mm
98397	5 m x 25 mm	8001066983971	6	54 x 56 mm
98399	8 m x 25 mm	8001066983995	6	64 x 68 mm

CHROME CASE BASIC

Cassa **cromata**
Chromed case
 Boîtier **chromé**
Verchromte Kapsel
 Estuche **cromado**



CE II

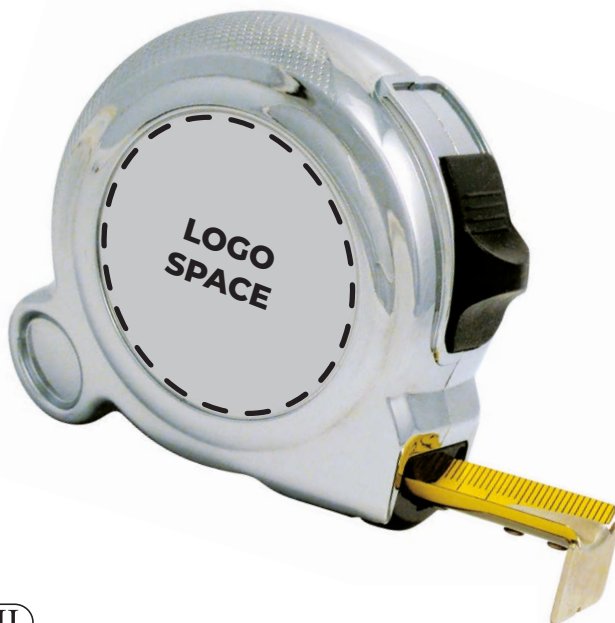

Ref.				Ø	
98192	2 m x 13 mm	8001066981922	6	41 mm	Stampa su etichetta in quadricromia <i>Four-colour label printing - Impression en quadrichromie sur étiquettes - Vierfarbendruck auf Etiketten - Impresión de la etiqueta en cuatricromía</i>
98193	3 m x 16 mm	8001066981939	6	41 mm	
98195	5 m x 19 mm	8001066981953	6	47 mm	
98196	5 m x 25 mm	8001066981960	6	47 mm	



CHROME CASE ROUND

Cassa **cromata**
Chromed case
 Boîtier **chromé**
Verchromte Kapsel
 Estuche **cromado**

CE II

Ref.				H x L	
98803	3 m x 16 mm	8001066988037	6	37 x 35 mm	Stampa su etichetta in quadricromia <i>Four-colour label printing - Impression en quadrichromie sur étiquettes - Vierfarbendruck auf Etiketten - Impresión de la etiqueta en cuatricromía</i>
98804	5 m x 19 mm	8001066988044	6	45 x 43 mm	
98805	5 m x 25 mm	8001066988051	6	45 x 43 mm	

MINI WHITE

Cassa in **ABS bianca**
 White **ABS case**
 Boîtier **ABS blanc**
 Weiße **ABS-Kapsel**
 Caja de **ABS blanca**



CE II



Ref.				Ø	Stampa su etichetta in quadricromia <i>Four-colour label printing - Impression en quadrichromie sur étiquettes - Vierfarbendruck auf Etiketten - Impresión de la etiqueta en cuatricromía</i>
98962	2 m x 13 mm	8001066989621	12	29 mm	



METRICA RUBBER TOUCH

Flessometro con **guaina in gomma**
 Case with **rubber**
 Boîtier avec **gaine en caoutchouc**
 Kapsel mit **Gummiüberzug**
 Caja funda **gomada**

CE II

Ref.				H x L	Stampa su etichetta in quadricromia <i>Four-colour label printing - Impression en quadrichromie sur étiquettes - Vierfarbendruck auf Etiketten - Impresión de la etiqueta en cuatricromía</i>
98793	3 m x 16 mm	8001066987931	12	38 x 38 mm	
98794	5 m x 19 mm	8001066987948	12	41 x 46 mm	
98795	5 m x 25 mm	8001066987955	6	41 x 46 mm	
98798	8 m x 25 mm	8001066987986	6	45 x 50 mm	

NEW



BLACK ABS

Cassa in **ABS nera**
Black **ABS case**
Boîtier en **ABS noir**
Schwarze **ABS-Kapsel**
Estuche de **ABS negro**

CE II

Ref.				Ø	
98042	2 m x 13 mm	8001066980420	12	38 mm	Stampa su etichetta in quadricromia <i>Four-colour label printing - Impression en quadrichromie sur étiquettes - Vierfarbendruck auf Etiketten - Impresión de la etiqueta en cuatricromía</i>
98043	3 m x 16 mm	8001066980437	12	38 mm	
98044	5 m x 19 mm	8001066980444	12	44 mm	



YELLOW ABS

Cassa in **ABS gialla**
Yellow **ABS case**
Boîtier en **ABS jaune**
Gelbe **ABS-Kapsel**
Estuche de **ABS amarillo**

CE II

Ref.				Ø	
98362	2 m x 13 mm	8001066983629	6	40 mm	Stampa su etichetta in quadricromia <i>Four-colour label printing - Impression en quadrichromie sur étiquettes - Vierfarbendruck auf Etiketten - Impresión de la etiqueta en cuatricromía</i>
98363	3 m x 16 mm	8001066983636	6	40 mm	
98365	5 m x 19 mm	8001066983650	6	45 mm	

ORANGE

Flessometro con **cassa bimateriale**
 Tape rule with **bimaterial case**
 Mètre ruban avec **boîtier bimatériel**
 Bandmaß mit **Bimaterialhülle**
 Flexòmetro con **caja bimaterial**



CE II

Ref.				Ø	
98633L	3 m x 16 mm	8001066986330	6	34 mm	Stampa su etichetta in quadricromia Four-colour label printing - Impression en quadrichromie sur étiquettes - Vierfarbendruck auf Etiketten - Impresión de la etiqueta en cuatricromía
98635L	5 m x 19 mm	8001066986354	6	39 mm	

MM / INCH ABS

Cassa in ABS, nastro **doppia graduazione mm/inch**
 ABS case, **graduation tape mm/inch**
 Boîtier en ABS, **ruban gradué mm/pouces**
 ABS-Kapsel, **doppelte Teilung mm/inch**
 Estuche de ABS, cinta de **doble graduación mm/pulgadas**

98309



98311

98309



98311



CE II

Ref.				Ø	
98309	5 m x 19 mm	8001066983094	6	45 mm	Stampa su etichetta in quadricromia Four-colour label printing - Impression en quadrichromie sur étiquettes - Vierfarbendruck auf Etiketten - Impresión de la etiqueta en cuatricromía
98311	3 m x 13 mm	8001066983117	6	42 mm	



METRICA TENDER

Cassa in ABS, **colori assortiti**



Red, green, yellow, black ABS case

Bâtier en ABS **rouge, vert, jaune, noir**

Rote, grüne, gelbe, schwarze ABS-Kapsel

Estuche de ABS **rojo, verde, amarillo, negro**



Ref.				H x L
98922	● 2 m x 13 mm	8001066989225	6	45 x 45 mm
98923	● 3 m x 13 mm	8001066989232	6	45 x 45 mm
98925	● 5 m x 19 mm	8001066989256	6	50 x 50 mm
98912	● 2 m x 13 mm	8001066989126	6	45 x 45 mm
98913	● 3 m x 13 mm	8001066989133	6	45 x 45 mm
98915	● 5 m x 19 mm	8001066989157	6	50 x 50 mm
98892	● 2 m x 13 mm	8001066988921	6	45 x 45 mm
98893	● 3 m x 13 mm	8001066988938	6	45 x 45 mm
98895	● 5 m x 19 mm	8001066988952	6	50 x 50 mm
98932	● 2 m x 13 mm	8001066989324	6	45 x 45 mm
98933	● 3 m x 13 mm	8001066989331	6	45 x 45 mm
98935	● 5 m x 19 mm	8001066989355	6	50 x 50 mm

Stampa su etichetta in quadricromia

Four-colour label printing - Impression en quadrichromie sur étiquettes - Vierfarbendruck auf Etiketten - Impresión de la etiqueta en cuatricromía

oppure - or - ou - oder - o

Stampa diretta massimo 1 colore - Direct printing maximum 1 color - Impression directe en 1 couleur maximum - Direktdruck maximal 1 Farbe - Impresión directa a 1 color como máximo



GIANT NUMBERS



METRICA TRANSPARENT

Nastro bianco, colori assortiti, **doppia graduazione (orizzontale + verticale)** - Cassa Trasparente

White tape, mixed colours, **double graduation (horizontal + vertical)** - Transparent case

Ruban blanc, couleurs panachées, **double graduation (horizontale + verticale)** - Boîtier transparent

Weißes Band, gemischte Farben, **doppelte Teilung (waagrecht + senkrecht)** - Durchsichtige Kapsel

Cinta blanca, colores mixtos, **graduación doble (horizontal + vertical)** - Estuche transparente



DOUBLE GRADUATION

Altri colori a richiesta - Other colors on request - Autres couleurs sur demande - Andere Farben auf Anfrage - Otros colores a petición



Ref.				H x L	
98751		8001066987511	6	28 x 38 mm	Stampa su etichetta in quadricromia
98761		8001066987610	6	28 x 38 mm	Four-colour label printing - Impression en quadrichromie sur étiquettes - Vierfarbendruck auf Etiketten - Impresión de la etiqueta en cuatricromía
98771		8001066987719	6	28 x 38 mm	oppure - or - ou - oder - o
98754		8001066987542	6	33 x 44 mm	Stampa diretta massimo 1 colore - Direct printing maximum 1 color - Impression directe en 1 couleur maximum - Direktdruck maximal 1 Farbe - Impresión directa a 1 color como máximo
98764		8001066987641	6	33 x 44 mm	
98774		8001066987740	6	33 x 44 mm	

DIAMETROMETRO MM / INCH

Diametrometro, **nastro in acciaio**

Anatomic gauge, **steel tape**

Pour mesures anatomiques, **ruban d'acier**

Anatomisches Messgerät, **Stahlband**

Para medidas anatomicas, **cinta de acero**



Ref.				H x L
38920	2 m x 10 mm	8001066389209	24	61 x 56 mm

Stampa su etichetta in quadricromia
Four-colour label printing - Impression en quadrichromie sur étiquettes - Vierfarbendruck auf Etiketten - Impresión de la etiqueta en cuatricromía

METRO PER SARTO AUTOMATICO

Metro per sarto - Rientro automatico

Taylor's tape - Automatic return

Mètre de couturier - Retour automatique

Schneidermaßband - Automatischer Rücklauf

Metro para sastre - Retorno automático

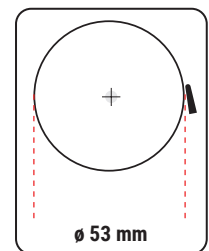

Ref.				∅
22105 ○	2 m	8001066221059	12	25 mm

Stampa su etichetta in quadricromia
Four-colour label printing - Impression en quadrichromie sur étiquettes - Vierfarbendruck auf Etiketten - Impresión de la etiqueta en cuatricromía



18080



18070

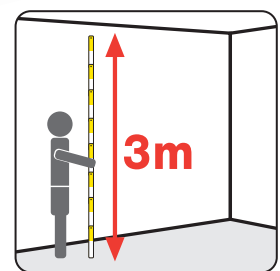
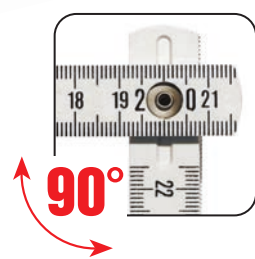

3 METRI FIBERGLASS

- 3m Gigante Fibra di vetro
- 3m Big size type Fiberglass
- 3m Géant Fibre de verre
- 3m Glasfaser
- 3m Fibra de vidrio gigante

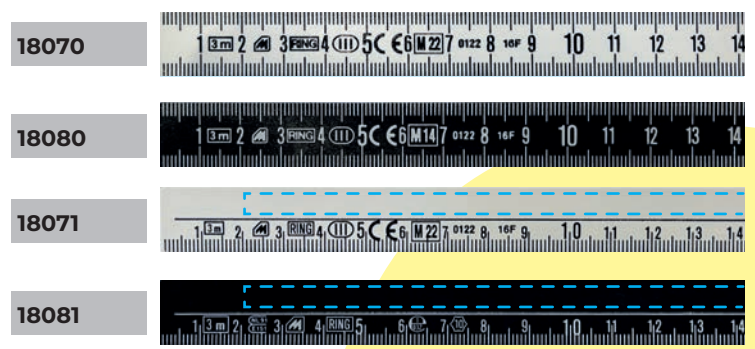

Ref.				H x L	Stampa su fianco Print on side Impression sur le côté Druck auf der Seite Impresión lateral	H x L		Stampa su stecca - Print on fold - Impression sur branche - Druck auf Anfangsglied - Impresión sobre varilla
18070 ○	3 m	8001066180707	10	40 x 160 mm				
18080 ●	3 m	8001066180806	10	40 x 160 mm				
18071 ○	3 m	8001066180714	10	40 x 160 mm		10 x 160 mm		
18081 ●	3 m	8001066180813	10	40 x 160 mm		10 x 160 mm		

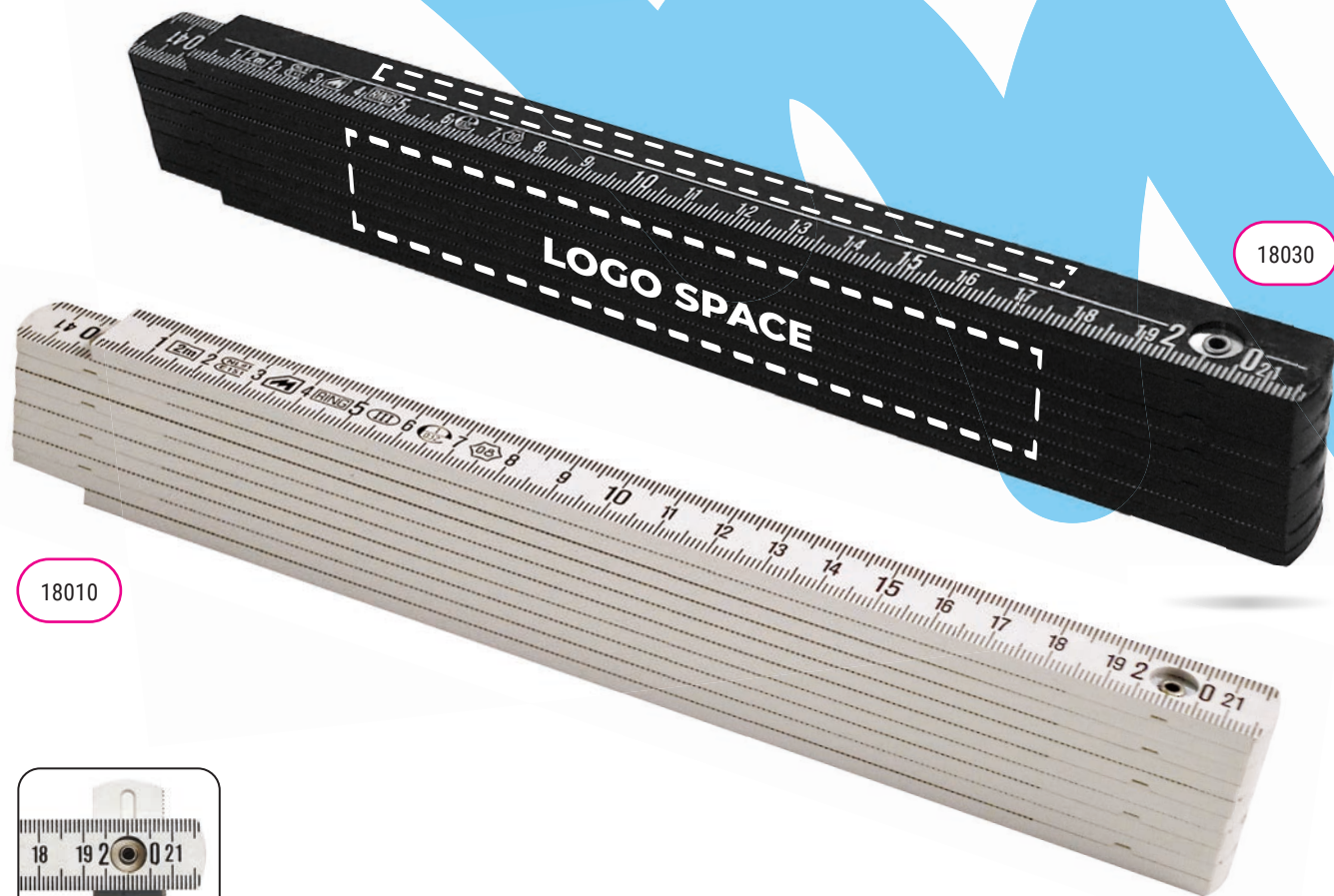

18030

18010

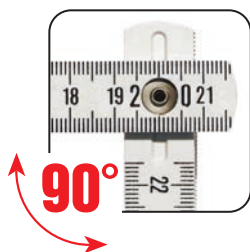

2 METRI FIBERGLASS

2m Fibra di vetro
2m Fiberglass
2m Fibre de verre
2m Glasfaser
2m Fibra de vidrio

CE III

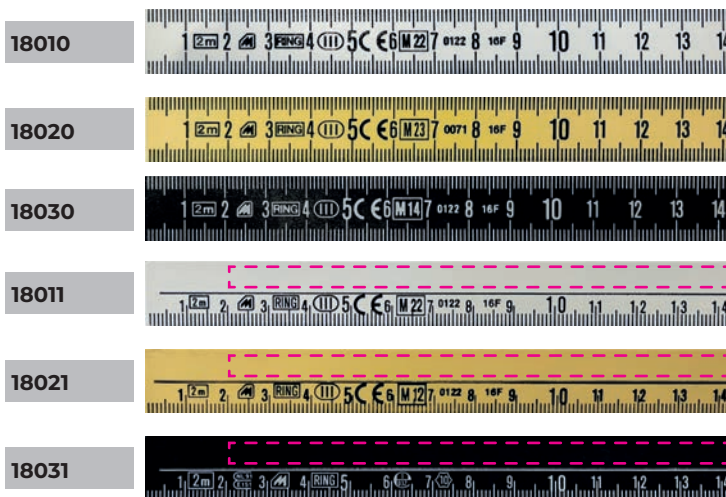

Ref.				H x L	Stampa su fianco Print on side Impression sur le côté Druck auf der Seite Impresión lateral	H x L		Stampa su stecca - Print on fold - Impression sur branche - Druck auf Anfangsglied - Impresión sobre varilla
18010 ○	2 m	8001066180103	12	27 x 160 mm	—	—		
18020 ●	2 m	8001066180202	12	27 x 160 mm	—	—		
18030 ●	2 m	8001066180301	12	27 x 160 mm	—	—		
18011 ○	2 m	8001066180110	12	27 x 160 mm	6 x 160 mm	6 x 160 mm		
18021 ●	2 m	8001066180219	12	27 x 160 mm	6 x 160 mm	6 x 160 mm		
18031 ●	2 m	8001066180318	12	27 x 160 mm	6 x 160 mm	6 x 160 mm		

NEW



2 METRI BICOLOR FIBERGLASS

- 2 m in fibra di vetro con **stecche alternate**
- 2 m fiberglass with **alternating folds**
- 2 m de fibre de verre à **branches alternées**
- 2 m Glasfaser mit **abwechselnden Gliedern**
- 2 m fibra de vidrio de con **varillas alternas**

Altri colori a richiesta - Other colors on request - Autres couleurs sur demande - Andere Farben auf Anfrage - Otros colores a petición

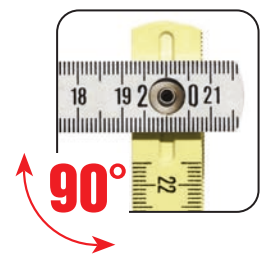

CE III

Ref.				H x L	
18000		8001066180004	12	27 x 160 mm	Stampa su fianco - Print on side Impression sur le côté - Druck auf der Seite - Impresión lateral
18002		8001066180028	12	27 x 160 mm	
18007		8001066180073	12	27 x 160 mm	

2 METRI MAGNET FIBERGLASS

2m Fibra di vetro con **aste calamitate**
 2m Fiberglass with **magnets**
 2m Fibre de verre avec **aimants**
 2m Glasfasergliedermaßstab mit **Magneten**
 2m Fibra de vidrio con **imanes**

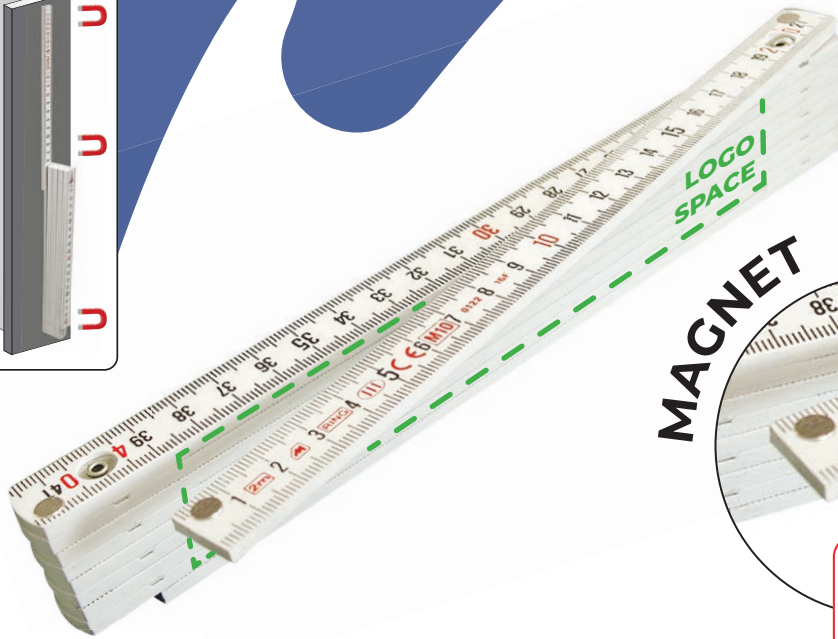
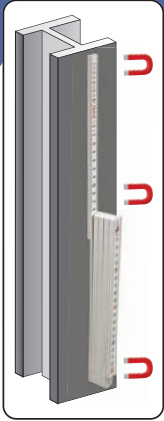

MAGNET

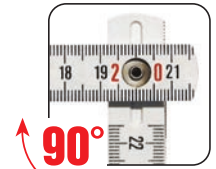
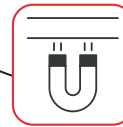
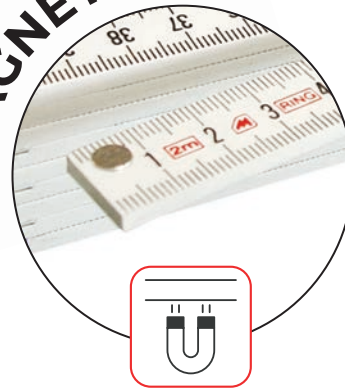

CE III



Ref.				H x L	
18005 ○	2 m	8001066180059	12	27 x 160 mm	<i>Stampa su fianco - Print on side</i> <i>Impression sur le côté - Druck auf der Seite - Impresión lateral</i>

2 METRI DECIMALI ROSSI FIBERGLASS

2m Fibra di vetro. **Decimali rossi**
 2m Fiberglass. **Red decimals**
 2m Fibre de verre. **Décimales en rouge**
 2m Glasfaser. **Rote Dezimalen**
 2m Fibra de vidrio. **Decimales en rojo**

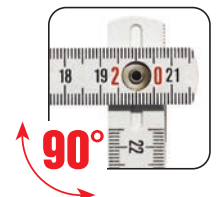
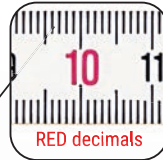
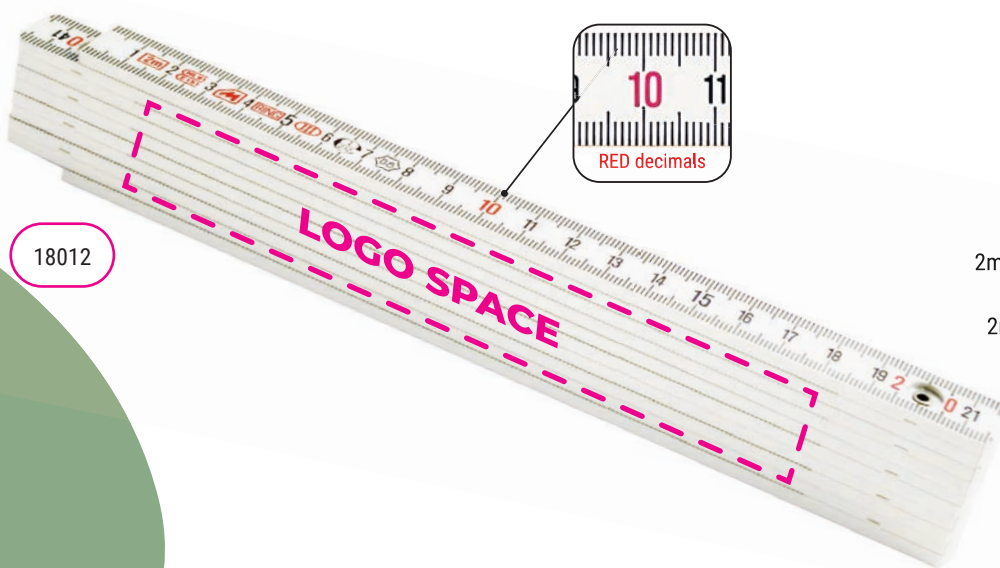

CE III

Ref.				H x L	H x L	
18012 ○	2 m	8001066180127	12	27 x 160 mm	—	<i>Stampa su stecca - Print on fold</i> <i>Impression sur branche - Druck auf Anfangsglied</i> <i>Impresión sobre varilla</i>
18013 ○	2 m	8001066180134	12	27 x 160 mm	6 x 160 mm	



90°



EASY READING

NEW GRADUATION



OTHER MODELS



2 METRI NEW GRADUATION FIBERGLASS

- 2 m fibra di vetro con **graduazione a lettura facilitata**, i numeri pari dei mm hanno un pallino di riconoscimento immediato.
- 2 m folding rule fibreglas with **graduation for easing reading**, even mm numbers have an immediate recognition dot.
- 2 m fibre de verre avec **graduation pour lecture facilitée**, les nombres pairs en mm ont un point de reconnaissance immédiate.
- 2 m Gliedermaßstab mit **Teilung für vereinfachtes Ablesen**, die geraden mm-Zahlen haben einen Punkt zur sofortigen Erkennung.
- 2 m fibra de vidrio con **graduación a lectura simplificada**, los números pares tienen un punto de reconocimiento inmediato.

Ref.				H x L	<i>Stampa su fianco - Print on side</i> <i>Impression sur le côté - Druck auf der Seite - Impresión lateral</i>
18019	2 m	8001066180196	12	27 x 160 mm	

2 METRI CON GANCIO FIBERGLASS

- 2m Fibra di vetro **con gancio**
- 2m Fiberglass **with hook**
- 2m Fibre de verre **avec crochet**
- 2m Glasfasergliedermaßstab **mit Haken**
- 2m Fibra de vidrio **con imanes gancho**

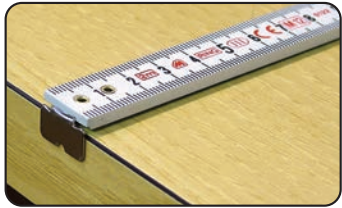
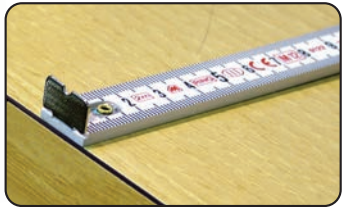
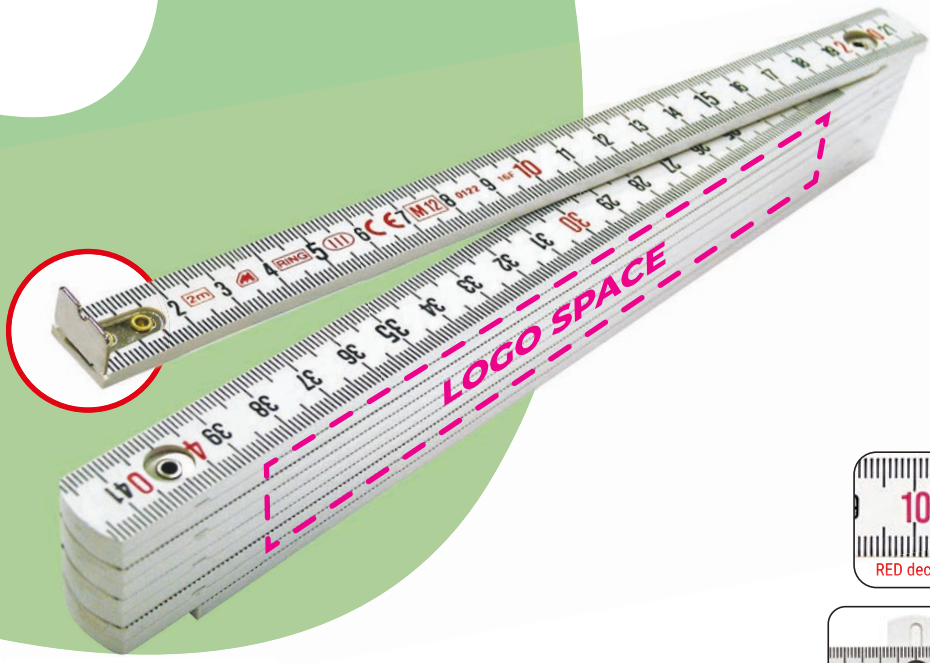

Ref.				H x L	
18004 ○	2 m	8001066180042	12	27 x 160 mm	<i>Stampa su fianco - Print on side</i> <i>Impression sur le côté - Druck auf der Seite - Impresión lateral</i>

2 METRI PER FALEGNAMI FIBERGLASS

- 2m Fibra di vetro. **Decimali rossi**
- 2m Fiberglass. **Red decimals**
- 2m Fibre de verre. **Décimales en rouge**
- 2m Glasfaser. **Rote Dezimalen**
- 2m Fibra de vidrio. **Decimales en rojo**

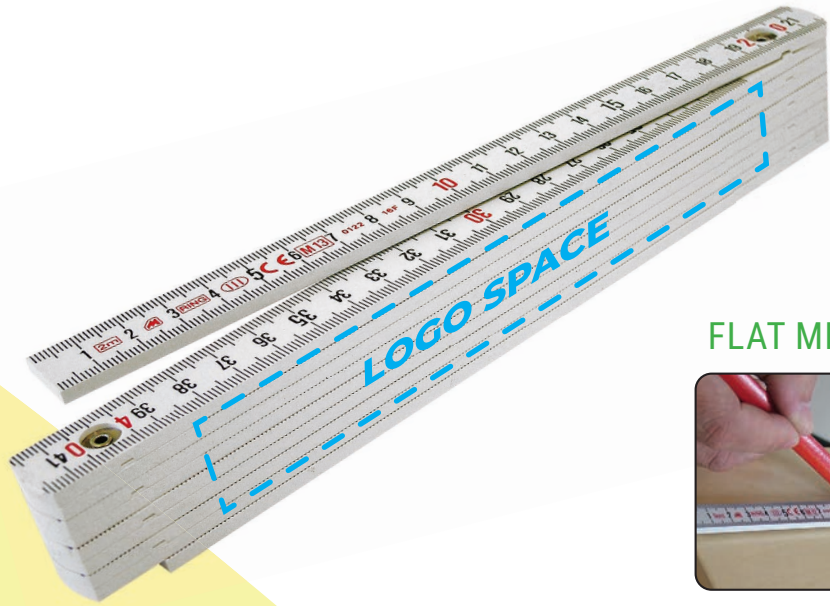

FLAT MEASURING

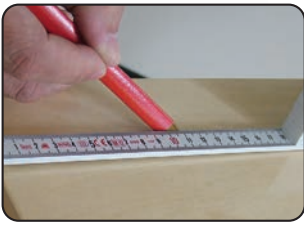

OTHER MODELS



FRONTE - FRONT
AVANT - VORDERSEITE
DELANTE

RETRO - BACK
DOS A - RÜCKSEITE
ATRÁS

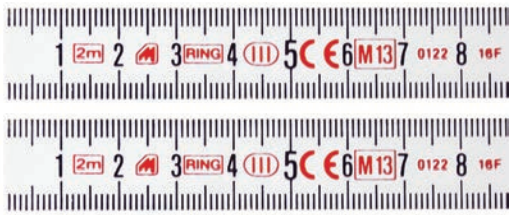

Ref.				H x L	
18006 ○	2 m	8001066180066	12	27 x 160 mm	<i>Stampa su fianco - Print on side</i> <i>Impression sur le côté - Druck auf der Seite - Impresión lateral</i>

1 METRO - ASTINA ESTENDIBILE PER BOCCE

FIBERGLASS

- 1m Fibra di vetro, **astina estendibile per bocce**
- 1m Fiberglass **extension rod**
- 1m Fibre de verre **à tirette**
- 1m Glasfaser **mit Stahlzunge**
- 1m Fibra de vidrio **con asta**

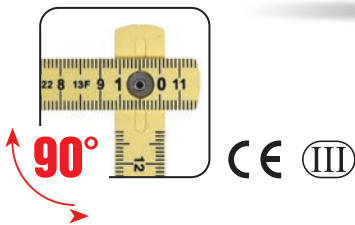

Ref.				H x L
20136	1 m	8001066201365	10	18 x 90 mm
<i>Stampa su fianco - Print on side</i> <i>Impression sur le côté - Druck auf der Seite - Impresión lateral</i>				

1 METRO FIBERGLASS

- 1m Fibra di vetro
- 1m Fiberglass
- 1m Fibre de verre
- 1m Glasfaser
- 1m Fibra de vidrio



CE III

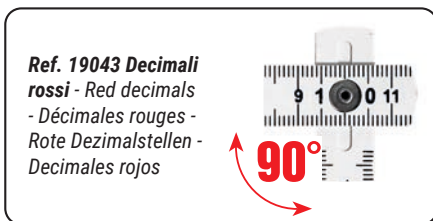



19050			
19060			

Ref.				H x L
19040 ○	1 m	8001066190409	12	18 x 90 mm
19050 ●	1 m	8001066190508	12	18 x 90 mm
19060 ●	1 m	8001066190607	12	18 x 90 mm
19043 ○	1 m	8001066190430	12	18 x 90 mm
<i>Stampa su fianco - Print on side</i> <i>Impression sur le côté - Druck auf der Seite - Impresión lateral</i>				

METRO PER SARTO

Metro per sarto
Taylor's tape
Mètre de couturier
Schneidermaßband, zweifarbig
Metro para sastre





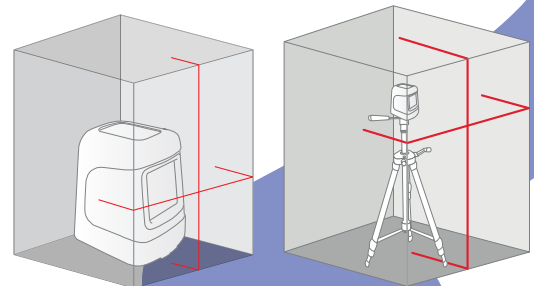

Ref.				H x L
22090	1,5 m	8001066220908	1	60 x 10 mm <i>Stampa diretta massimo 1 colore - Direct printing maximum 1 color - Impression directe en 1 couleur maximum - Direktdruck maximal 1 Farbe - Impresión directa a 1 color como máximo</i>

BRAVO LASERBOX

Autolivello laser a croce **10m**
Autoleveling cross laser **10m**
Niveau laser à croix **10m**
Selbstnivellierenders Kreuzlaser **10m**
Nivel laser automático **10m**



Ref.					H x L
61300	10 m	82 x 57 x 90 mm	8001066613007	1	30 x 40 mm <i>Stampa su etichetta in quadricromia - Four-colour label printing - Impression en quadrichromie sur étiquettes - Vierfarbendruck auf Etiketten - Impresión de la etiqueta en cuatricromía</i>

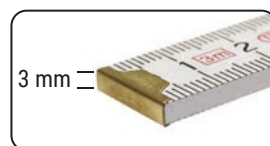
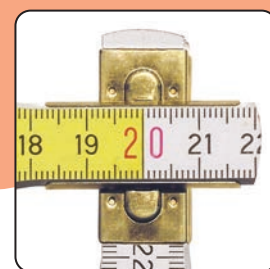
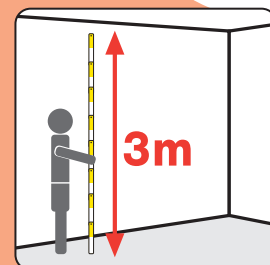

3 METRI WOOD

- 3m Legno, **gigante, perni invisibili, decimali rossi**
- 3m Wooden, **big size type, hidden rivets, red decimals**
- 3m Bois, **géant, rivets invisibles, décimales en rouge**
- 3m Holz, **Verdeckte Nieten, Rote Dezimalen**
- 3m Madera, **rivetes invisibles, decimales en rojo**



Ref.				H x L	<i>Stampa su fianco - Print on side</i> <i>Impression sur le côté - Druck auf der Seite - Impresión lateral</i>
23169	3 m	8001066231690	10	40 x 140 mm	

2 METRI WOOD

2m Legno, **semigigante, molle interne**
 2m Wooden, **semi-giant, inside springs**
 2m Bois, **semi-géant, ressorts incorporés**
 2m Holz, **Buchenholz, Innenfedern**
 2m Madera, **semigigante, resortes interiores**

23080

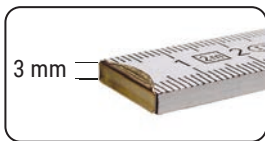
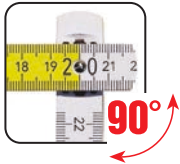

CE III

23081



Ref.				H x L	Stampa su fianco Print on side Impression sur le côté Druck auf der Seite Impresión lateral	H x L	Stampa su stecca - Print on fold - Impression sur branche - Druck auf Anfangsglied - Impresión sobre varilla
23080		8001066230808	10	27 x 160 mm		6 x 160 mm	
23081		8001066230815	10	27 x 160 mm			

2 METRI NATURALE WOOD

2m Legno naturale
 2m Natural wood
 2m Bois naturel
 2m Naturholz
 2m Madera natural

23090

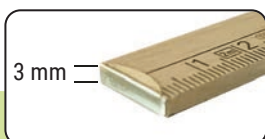
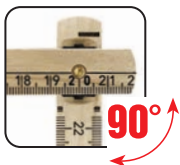

CE III

23091



23093



Ref.				H x L	Stampa su fianco Print on side Impression sur le côté Druck auf der Seite Impresión lateral	H x L	Stampa su stecca - Print on fold - Impression sur branche - Druck auf Anfangsglied - Impresión sobre varilla
23090		8001066230907	10	27 x 160 mm		6 x 160 mm	
23091		8001066230914	10	27 x 160 mm			
23093		8001066230938	10	27 x 160 mm			

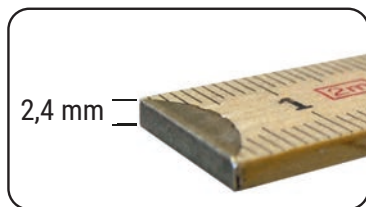
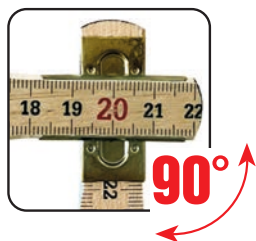
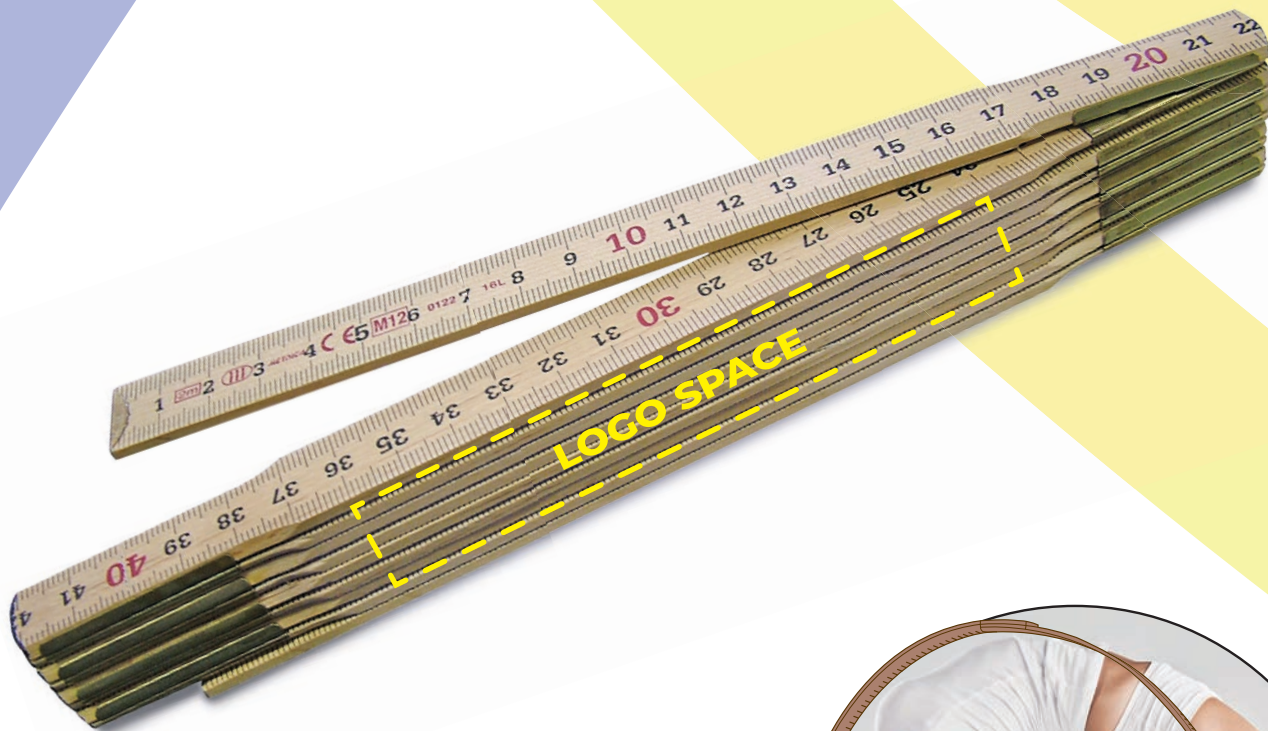

2 METRI BETULLA WOOD

2m betulla, modello professionale, **decimali rossi, super flessibile**

2m birch, professional model, **red decimals, super flexible**

2m bouleau, modèle professionnel, **décimales rouges, super flexible**

2m Birke, professionelle Ausführung, **rote Dezimalen, super flexibel**

2m abedul, modelo profesional, **decimales rojos, super flexible**



Ref.				H x L	Stampa su fianco - Print on side <i>Impression sur le côté - Druck auf der Seite - Impresión lateral</i>
23300	2 m	8001066233007	10	21 x 140 mm	

2 METRI PROFESSIONAL WOOD

2m Legno, **decimali rossi**
 2m Wooden, **red decimals**
 2m Bois, **décimales en rouge**
 2m Holz, **Rote Dezimalen**
 2m Madera, **decimales en rojo**

23160

CE III

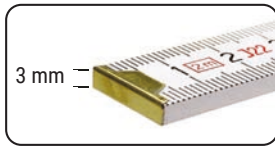

23161



Ref.				H x L	Stampa su fianco Print on side Impression sur le côté Druck auf der Seite Impresión lateral	H x L		Stampa su stecca - Print on fold - Impression sur branche - Druck auf Anfangsglied - Impresión sobre varilla
23160	2 m	8001066231607	10	27 x 140 mm		-		
23161	2 m	8001066231614	10	27 x 140 mm		6 x 160 mm		

2 METRI PROFESSIONAL WOOD

2m Legno, **decimali rossi**
 2m Wooden, **red decimals**
 2m Bois, **décimales en rouge**
 2m Holz, **Rote Dezimalen**
 2m Madera, **decimales en rojo**

23162

CE III

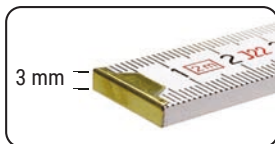

23163



Ref.				H x L	Stampa su fianco Print on side Impression sur le côté Druck auf der Seite Impresión lateral	H x L		Stampa su stecca - Print on fold - Impression sur branche - Druck auf Anfangsglied - Impresión sobre varilla
23162	2 m	8001066231621	10	27 x 140 mm		-		
23163	2 m	8001066231638	10	27 x 140 mm		6 x 160 mm		

2 METRI SEMIGIGANTE WOOD



- 2m Legno, **semigigante professionale, decimali rossi**
- 2m Wooden, **profesional model, red decimals**
- 2m Bois, **modèle professionnel, décimales en rouge**
- 2m Holz, **Professionelles Modell, Rote Dezimalen**
- 2m Madera, **modelo profesional, decimales en rojo**

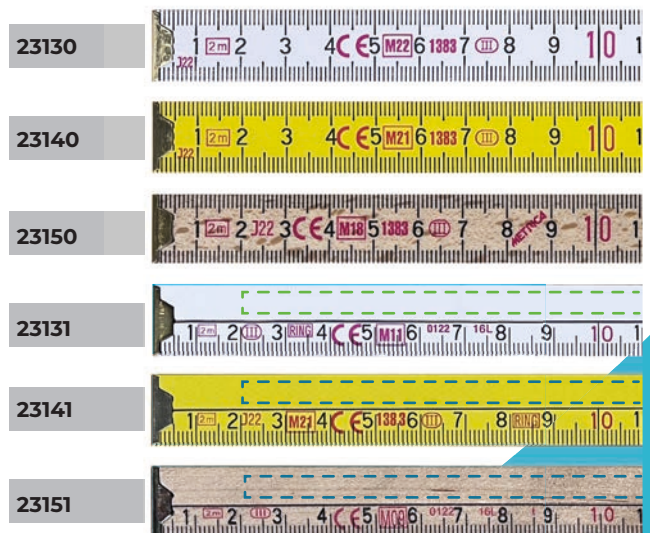
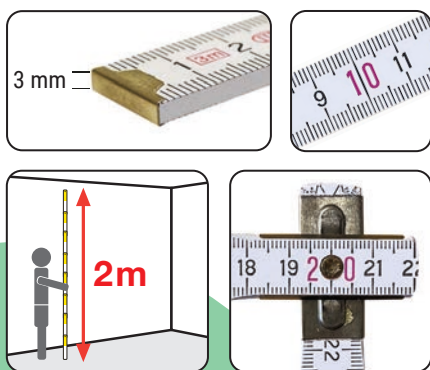

Ref.				H x L	Stampa su fianco Print on side Impression sur le côté Druck auf der Seite Impresión lateral	H x L		Stampa su stecca - Print on fold - Impression sur branche - Druck auf Anfangsglied - Impresión sobre varilla
23130 ○	2 m	8001066231300	10	27 x 140 mm	-	-		-
23140 ●	2 m	8001066231409	10	27 x 140 mm	-	-		-
23150 ●	2 m	8001066231508	10	27 x 140 mm	-	-		-
23131 ○	2 m	8001066231317	10	27 x 140 mm	6 x 160 mm	-		-
23141 ●	2 m	8001066231416	10	27 x 140 mm	6 x 160 mm	-		-
23151 ●	2 m	8001066231515	10	27 x 140 mm	6 x 160 mm	-		-

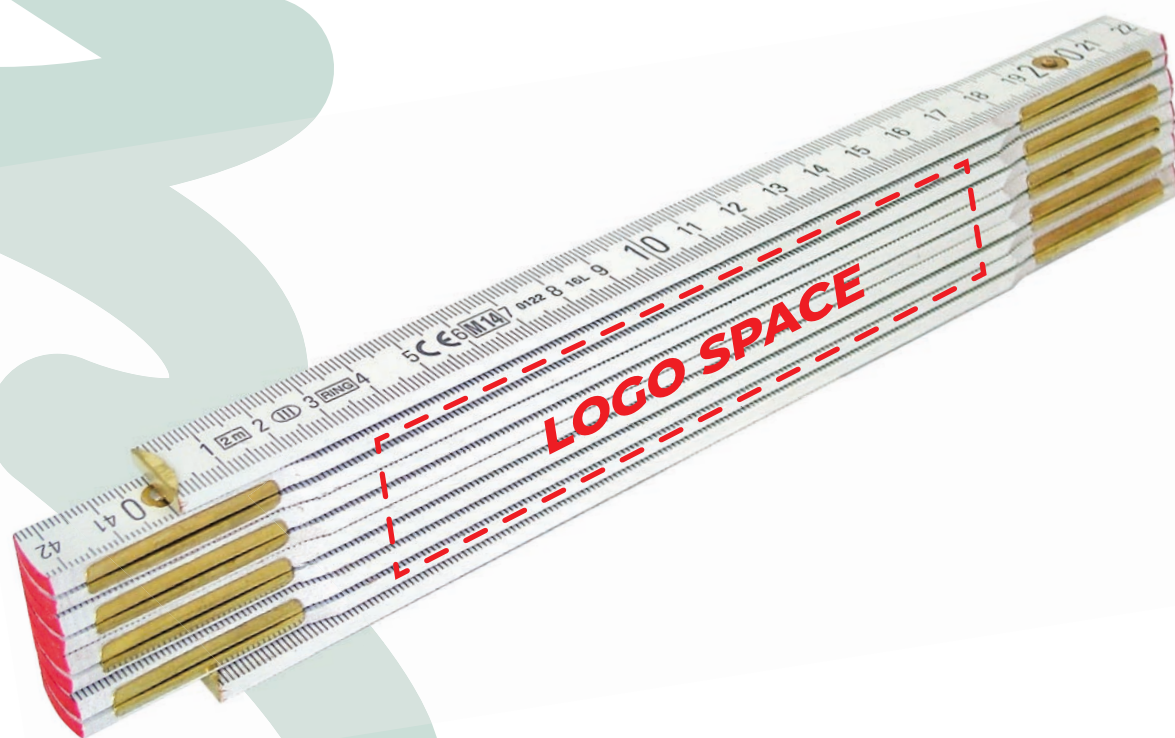

2 METRI MODELLI PROFESSIONALI WOOD



2m legno, **modello professionale**

2m Wooden, **profesional model**

2m Bois, **modèle professionnel**

2m Holz, **professionelles Modell**

2m Madera, **modelo profesional**

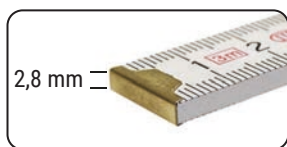
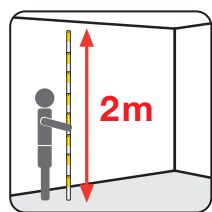

23126



23127

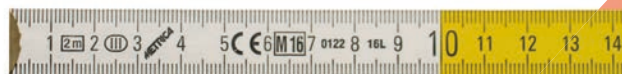

23128



Ref.



H x L

23126 ●
23127 ●
23128 ○

2 m
2 m
2 m

8001066231263
8001066231270
8001066231287

10
10
10

27 x 160 mm
27 x 160 mm
27 x 160 mm

Stampa su fianco - Print on side
Impression sur le côté - Druck auf der Seite - Impresión lateral

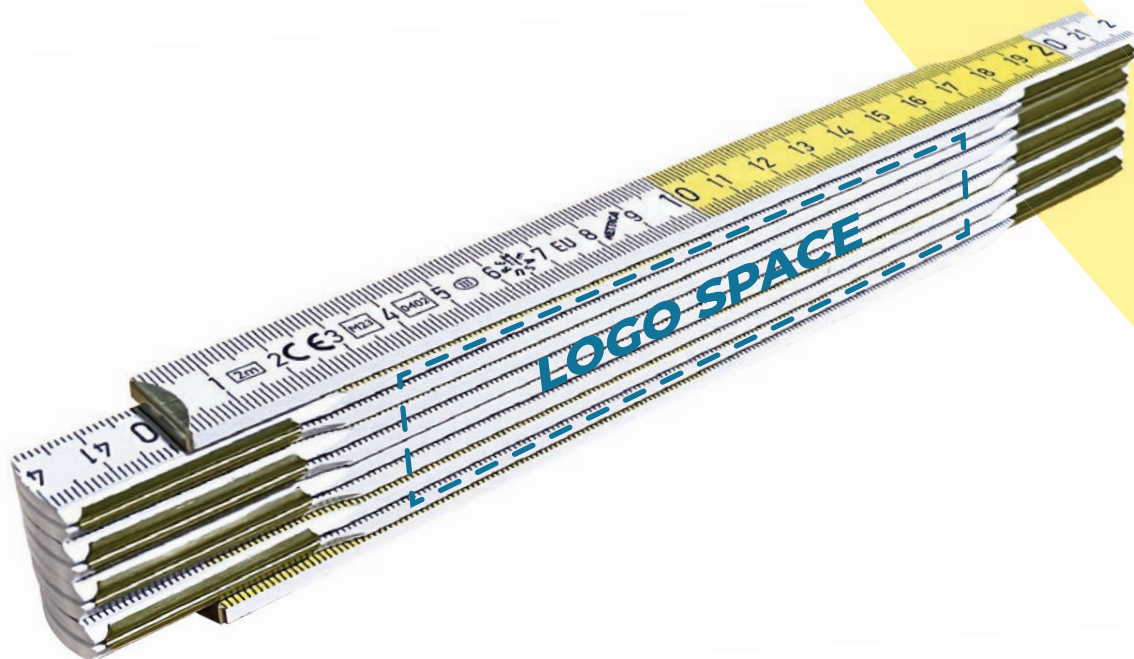

2 METRI MODELLI PROFESSIONALI WOOD

CE III

2m legno, modello professionale, **perni invisibili**

2m Wooden, profesional model, **hidden rivets**

2m Bois, modèle professionnel, **rivets invisibles**

2m Holz, Professionelles Modell, **Innenfedern**

2m Madera, modelo profesional, **rivetes invisibles**

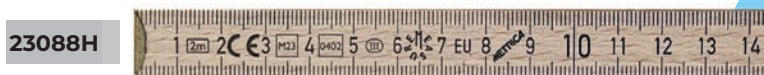
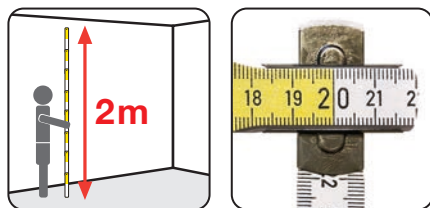

Ref.			
23085H	2 m	8001066230853	10
23087H	2 m	8001066230877	10
23088H	2 m	8001066230884	10

H x L

27 x 160 mm *Stampa su fianco - Print on side*
 27 x 160 mm *Impression sur le côté - Druck auf der Seite - Impresión lateral*
 27 x 160 mm

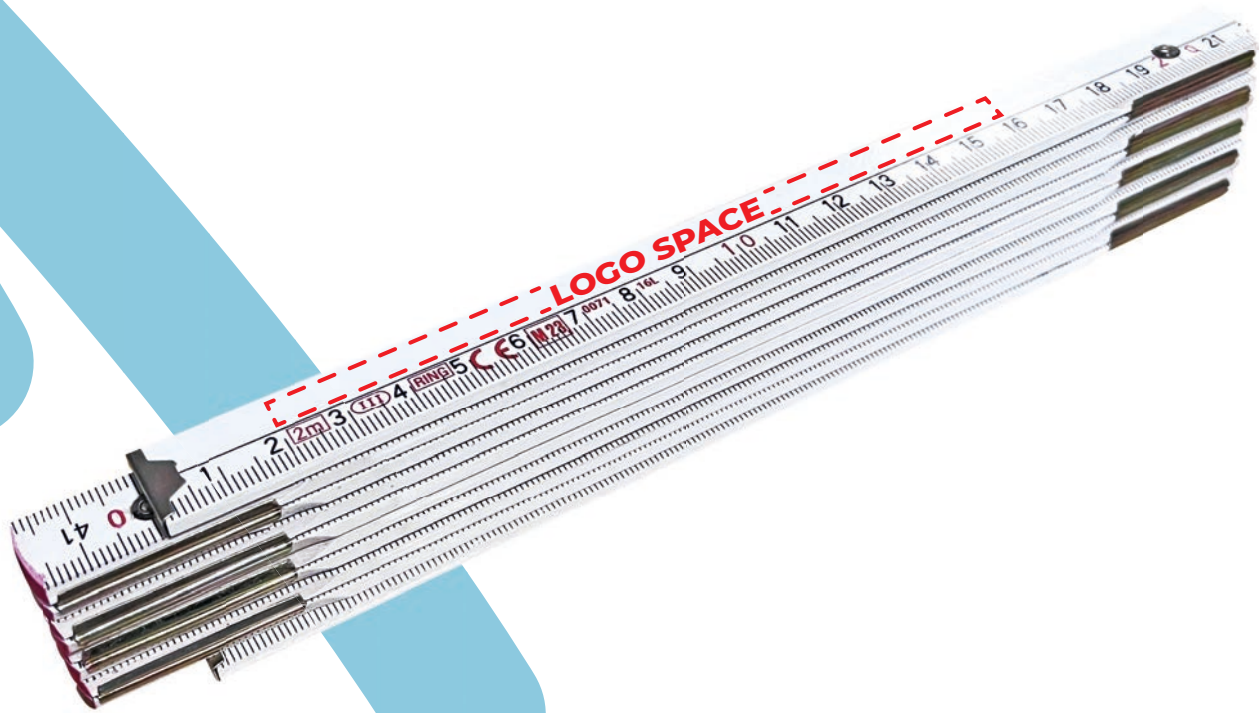

2 METRI DECIMALI ROSSI WOOD

2m Legno - **Decimali rossi**

2m Wooden - **Red decimals**

2m Bois - **Décimales en rouge**

2m Holz - **Rote Dezimalen**

2m Madera - **Decimales en rojo**

Ref. 23211 - Perni invisibili - hidden rivets - rivets invisible - Innenfedern - rivetes invisible

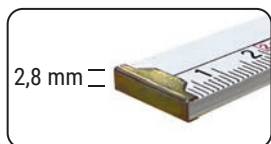
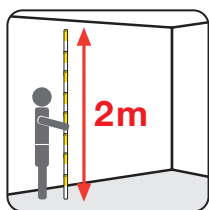

23153



23168



23111
23211



23121



Ref.				H x L	
23153	2 m	8001066231539	10	6 x 160 mm	<i>Stampa su stecca - Print on fold - Impression sur branche Druck auf Anfangsglied - Impresión sobre varilla</i>
23168	2 m	8001066231683	10	6 x 160 mm	
23111	2 m	8001066231119	10	6 x 160 mm	
23121	2 m	8001066231218	10	6 x 160 mm	
23211	2 m	8001066232116	10	6 x 160 mm	



ASTA IN LEGNO

- 1 Metro ad asta in legno grad. cm
- 1 Taylor's wooden rule grad. cm
- 1 Mètre de couturier bois grad. cm
- 1 Holz-Schneidmaßtab cm - Teilung
- 1 Metro para sastre madera grad. cm

CE III

Ref.	L cm			H x L	
22071	100	8001066220717	1	15 mm x 1m / 10 x 70 mm	Stampa diretta massimo 1 colore - Direct printing maximum 1 color - Impression directe en 1 couleur maximum - Direktdruck maximal 1 Farbe - Impresión directa a 1 color como máximo
22074	50	8001066220748	1	15 mm x 0,50 m / 10 x 70 mm	



INCLINOMETRO A QUADRANTE

- Inclinometro a quadrante
- Slope level
- Niveau pour inclinaison
- Neigungswasserwaage
- Nivel de inclinaciones



Ref.			Ø	
33270	8001066332700	10	45 mm	Stampa su etichetta in quadricromia Four-colour label printing - Impression en quadrichromie sur étiquettes - Vierfarbendruck auf Etiketten - Impresión de la etiqueta en cuatricromía

NEW

CUTTER "ALL BLACK"

Corpo in ABS, lame 18 x 0,7 mm
 ABS body, blades 18 x 0.7 mm
 Corps en ABS, lames 18 x 0,7 mm
 ABS-Körper, Klingen 18 x 0,7 mm
 Cuerpo ABS, cuchillas 18 x 0,7 mm

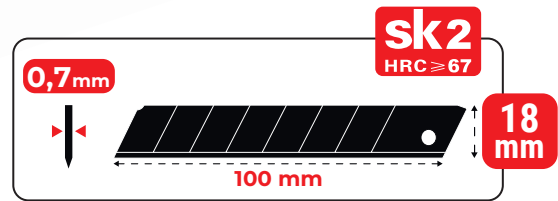

Ref.	L			H x L
09031	160 mm	8001066090310	12	10 x 39 mm <i>Stampa su etichetta in quadricromia Four-colour label printing - Impression en quadrichromie sur étiquettes - Vierfarbendruck auf Etiketten - Impresión de la etiqueta en cuatricromía</i>

NEW



CUTTER "ALL BLACK" CON VITE DI BLOCCAGGIO

Cutter **professionale**, corpo in ABS gommatto, lame 18 x 0,7 mm
 Professional cutter, **ABS body**, blades 18 x 0.7 mm
 Cutter **professionnel**, corps en ABS, lames 18 x 0,7 mm
 Profi-Cutter, **ABS-Körper**, Klingen 18 x 0,7 mm
 Cúter **profesional**, cuerpo ABS, cuchillas 18 x 0,7 mm

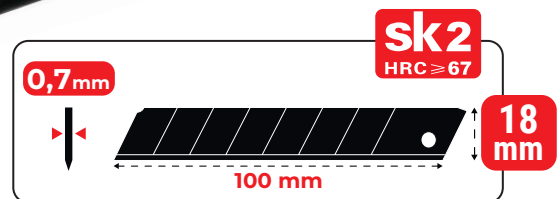

Ref.	L			H x L
09033	185 mm	8001066090334	12	10 x 39 mm <i>Stampa su etichetta in quadricromia Four-colour label printing - Impression en quadrichromie sur étiquettes - Vierfarbendruck auf Etiketten - Impresión de la etiqueta en cuatricromía</i>

NEW

CUTTER "ALL BLACK" 25 MM CON VITE DI BLOCCAGGIO



Cutter **professionale**, lame 25 x 0,7 mm, **altamente resistente**
Professional cutter, blades 25 x 0.7 mm, **highly resistant**
 Cutter **professionnel**, lames 25 x 0,7 mm, **très résistantes**
Profi-Cutter, Klingen 25 x 0,7 mm, **hochbeständig**
 Cúter **profesional**, cuchillas 25 x 0,7 mm, **muy resistente**

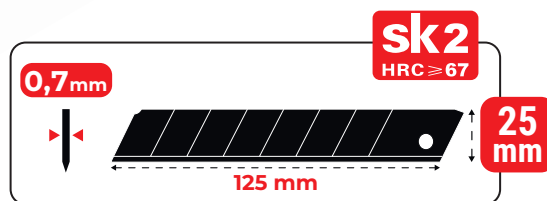

Ref.	L			H x L
09037	160 mm	8001066090372	12	10 x 39 mm

Stampa su etichetta in quadricromia
Four-colour label printing - Impression en quadrichromie sur étiquettes - Vierfarbendruck auf Etiketten - Impresión de la etiqueta en cuatricromía

NEW



CUTTER "ALL BLACK" CON VITE DI BLOCCAGGIO

Cutter **professionale**, corpo in metallo gommato, impugnatura antiscivolo, lame 18 x 0,7 mm, **altamente resistente**
Professional cutter, rubberized metal body, non-slip grip, blades 18 x 0.7 mm, **highly resistant**
 Cutter **professionnel**, corps en métal caoutchouté, poignée antidérapante, lames 18 x 0,7 mm, **très résistant**
Profi-Cutter, gummiertes Metallgehäuse, rutschfester Griff, Klingen 18 x 0,7 mm, **hochbeständig**
 Cutter **profesional**, cuerpo metálico engomado, empuñadura antideslizante, cuchillas 18 x 0,7 mm, **muy resistente**

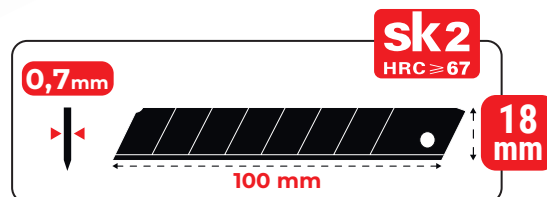

Ref.	L			H x L
09039	185 mm	8001066090396	12	10 x 39 mm

Stampa su etichetta in quadricromia
Four-colour label printing - Impression en quadrichromie sur étiquettes - Vierfarbendruck auf Etiketten - Impresión de la etiqueta en cuatricromía

NEW

CUTTER BLACK BLADE OPEN&CUT

Corpo in ABS, lame 18 x 0,7 mm
 ABS body, blades 18 x 0.7 mm
 Corps en ABS, lames 18 x 0,7 mm
 ABS-Körper, Klingen 18 x 0,7 mm
 Cuerpo ABS, cuchillas 18 x 0,7 mm

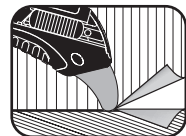

MOQUETTE

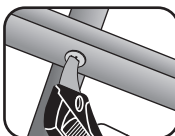

VITI

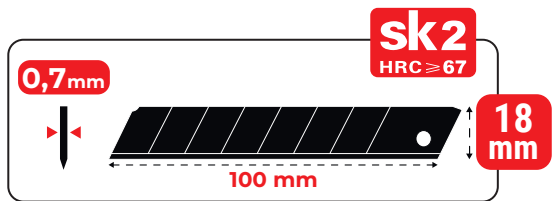

Ref.	L		
09068	170 mm	8001066090686	12

H x L
 10 x 39 mm

Stampa su etichetta in quadricromia
 Four-colour label printing - Impression en quadricromie sur étiquettes - Vierfarbendruck auf Etiketten - Impresión de la etiqueta en cuatricromía

NEW

CUTTER BLACK BLADE TASCABILE 18 MM*

Cutter tascabile, corpo in ABS, lama 18 x 0,7 mm
 Pocket cutter, rubberized ABS body, blade 18 x 0.7 mm
 Cutter de poche, corps en ABS caoutchouté, lame 18 x 0,7 mm
 Taschenmesser, gummiertes ABS-Gehäuse, Klinge 18 x 0,7 mm
 Cúter de bolsillo, Cuerpo de ABS engomado, hoja 18 x 0,7 mm

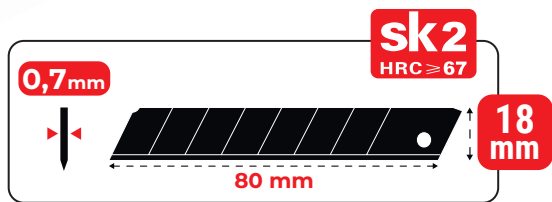

Ref.	L		
09025	185 mm	8001066090259	12

H x L
 10 x 39 mm

Stampa su etichetta in quadricromia
 Four-colour label printing - Impression en quadricromie sur étiquettes - Vierfarbendruck auf Etiketten - Impresión de la etiqueta en cuatricromía



CUTTER PIATTO CON LAMA RETRATTILE

Cutter piatto di sicurezza **lama retrattile a molla**
Cutter safety lock **spring self retr. blade**
Cutter de sécurité **lame retractile à ressort**
Flaches Messer, **Feder-Klingenrückgang**
Cúter de seguridad resorte
de **recuperacion automatico**



19
mm

60 mm

Ref.	H x L			H x L	
49001	125 x 29 mm	8001066490011	10	13 x 60 mm	<p>Stampa su etichetta in quadricromia Four-colour label printing - Impression en quadrichromie sur étiquettes - Vierfarbendruck auf Etiketten - Impresión de la etiqueta en cuatricromía oppure - or - ou - oder - o</p> <p>Stampa diretta massimo 1 colore - Direct printing maximum 1 color - Impression directe en 1 couleur maximum - Direktdruck maximal 1 Farbe - Impresión directa a 1 color como máximo</p>

CUTTER IN METALLO

Cutter metallo **lama trapezoidale**
Metal body **trapezoidal blade**
Corps en métal **lame trapézoïdale**
Metallgehäuse, **Trapez-Klinge**
Cuerpo de metal **cuchilla trapezoidal**



19
mm

60 mm

Ref.	H x L			H x L	
49117	150 x 30 mm	8001066491179	6	12 x 35 mm	<p>Stampa su etichetta in quadricromia Four-colour label printing - Impression en quadrichromie sur étiquettes - Vierfarbendruck auf Etiketten - Impresión de la etiqueta en cuatricromía oppure - or - ou - oder - o</p> <p>Stampa diretta massimo 1 colore - Direct printing maximum 1 color - Impression directe en 1 couleur maximum - Direktdruck maximal 1 Farbe - Impresión directa a 1 color como máximo</p>

CUTTER METALLICO PIATTO

Cutter piatto in metallo,
guida lama in metallo

Metal body, safety lock

Corps en métal, blocage de sécurité

Metallgehäuse, Sicherheits-Feststellung

Cuerpo de metal, freno de seguridad

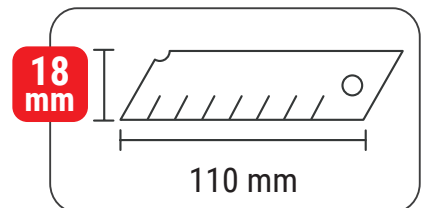

Ref.	H x L		
49012	175 x 38 mm	8001066490127	10

H x L

10 x 35 mm

Stampa su etichetta in quadricromia

Four-colour label printing - Impression en quadrichromie sur étiquettes - Vierfarbendruck auf Etiketten - Impresión de la etiqueta en cuatricromía
oppure - or - ou - oder - o

Stampa diretta massimo 1 colore - Direct printing maximum 1 color - Impression directe en 1 couleur maximum - Direktdruck maximal 1 Farbe - Impresión directa a 1 color como máximo



CUTTER BLOCCALAMA

Cutter guida lama in metallo

Cutter metal rail

Cutter guide de lame en métal

Cutter, Metallschiene für Klinge

Cúter guía en metal

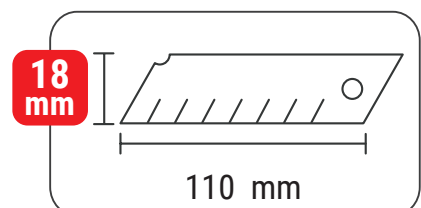

Ref.	H x L		
49023	150 x 40 mm	8001066982200	12

H x L

5 x 80 mm

Stampa su etichetta in quadricromia

Four-colour label printing - Impression en quadrichromie sur étiquettes - Vierfarbendruck auf Etiketten - Impresión de la etiqueta en cuatricromía
oppure - or - ou - oder - o

Stampa diretta massimo 1 colore - Direct printing maximum 1 color - Impression directe en 1 couleur maximum - Direktdruck maximal 1 Farbe - Impresión directa a 1 color como máximo

CUTTER BLOCCALAMA

Cutter guida lama in metallo
Cutter metal rail
Cutter guide de lame en métal
Cutter, Metallschiene für Klinge
Cúter guía en metal



18
mm

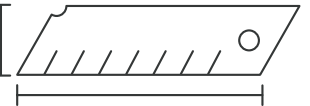

110 mm

Ref.	H x L			H x L	
49018	150 x 30 mm	8001066490233	20	7 x 80 mm	<p>Stampa su etichetta in quadricromia Four-colour label printing - Impression en quadrichromie sur étiquettes - Vierfarbendruck auf Etiketten - Impresión de la etiqueta en cuatricromía oppure - or - ou - oder - o</p> <p>Stampa diretta massimo 1 colore - Direct printing maximum 1 color - Impression directe en 1 couleur maximum - Direktdruck maximal 1 Farbe - Impresión directa a 1 color como máximo</p>

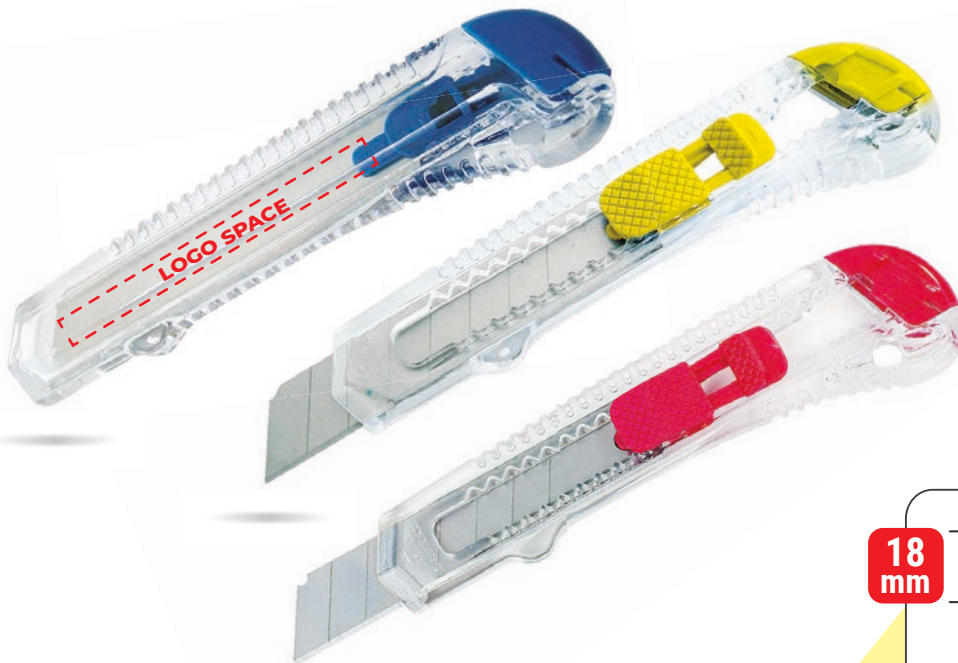

CUTTER TRASPARENTI

Cutters trasparenti
Transparent cutters
Cutters transparents
Cutter Messer
Cúteres transparentes

18
mm

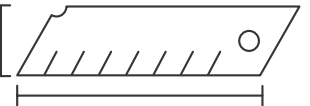

110 mm

Ref.	H x L			H x L	
49095 	150 x 40 mm	8001066490950	10	7 x 80 mm	<p>Stampa su etichetta in quadricromia Four-colour label printing - Impression en quadrichromie sur étiquettes - Vierfarbendruck auf Etiketten - Impresión de la etiqueta en cuatricromía oppure - or - ou - oder - o</p> <p>Stampa diretta massimo 1 colore - Direct printing maximum 1 color - Impression directe en 1 couleur maximum - Direktdruck maximal 1 Farbe - Impresión directa a 1 color como máximo</p>
49096 	150 x 40 mm	8001066490967	10	7 x 80 mm	
49097 	150 x 40 mm	8001066490974	10	7 x 80 mm	

CUTTER INSTANT STOP



Cutter **professionale bloccalama automatico**
Professional cutter self locking blade
 Cutter **professionnel lame de blocage automatique**
Professional Cutter, selbst-blockierende Klinge
 Cúter **profesional lama auto-bloqueante**

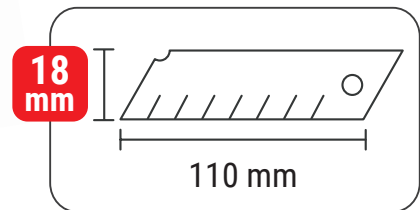

Ref.	H x L			H x L
49130	150 x 40 mm	8001066491308	10	10 x 39 mm

Stampa su etichetta in quadricromia
 Four-colour label printing - Impression en quadrichromie sur étiquettes - Vierfarbendruck auf Etiketten - Impresión de la etiqueta en cuatricromía



CUTTER DI SICUREZZA

Corpo in metallo
 Metal body
 Corps en métal
 Metallgehäuse
 Cuerpo de metal

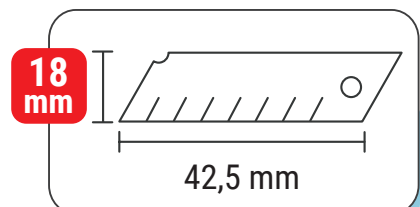
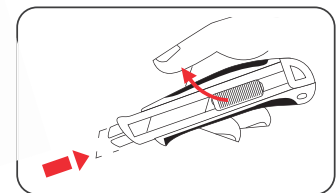

Ref.	H x L			H x L
49121	155 x 40 mm	8001066491216	10	10 x 70 mm

Stampa su etichetta in quadricromia
 Four-colour label printing - Impression en quadrichromie sur étiquettes - Vierfarbendruck auf Etiketten - Impresión de la etiqueta en cuatricromía
 oppure - or - ou - oder - o

Stampa diretta massimo 1 colore - Direct printing maximum 1 color - Impression directe en 1 couleur maximum - Direktdruck maximal 1 Farbe - Impresión directa a 1 color como máximo

CUTTER BLADE

Cutter piatto di sicurezza lama retrattile a molla

Cutter safety lock spring, self retr. blade

Cutter de sécurité, lame retractile à ressort

Flacher Cutter, Feder-Klingentrückgang

Cúter de seguridad, resorte de recuperacion automatico

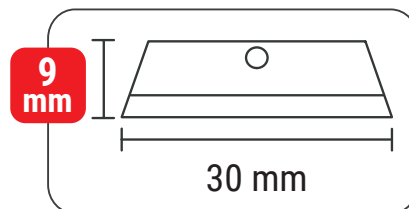
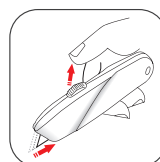

Ref.	H x L			H x L
49000	80 x 17 mm	8001066490004	100	5 x 30 mm

Stampa su etichetta in quadricromia
 Four-colour label printing - Impression en quadrichromie sur étiquettes - Vierfarbendruck auf Etiketten - Impresión de la etiqueta en cuatricromía
 oppure - or - ou - oder - o

Stampa diretta massimo 1 colore - Direct printing maximum 1 color - Impression directe en 1 couleur maximum - Direktdruck maximal 1 Farbe - Impresión directa a 1 color como máximo

CUTTER TRASPARENTI

Cutters trasparenti

Transparent cutters

Cutters transparents

Durchsichtige Cutter

Cúteres transparentes

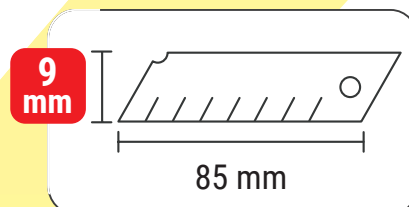

Ref.	H x L			H x L
49090	130 x 16 mm	8001066490189	10	4,5 x 55 mm
49091	130 x 16 mm	8001066490905	10	4,5 x 55 mm
49092	130 x 16 mm	8001066490912	10	4,5 x 55 mm

Stampa su etichetta in quadricromia
 Four-colour label printing - Impression en quadrichromie sur étiquettes - Vierfarbendruck auf Etiketten - Impresión de la etiqueta en cuatricromía
 oppure - or - ou - oder - o

Stampa diretta massimo 1 colore - Direct printing maximum 1 color - Impression directe en 1 couleur maximum - Direktdruck maximal 1 Farbe - Impresión directa a 1 color como máximo

NEW



CUTTER METAL BODY

Cutter tascabile, **corpo in metallo**
 Pocket cutter, **metal body**
 Cutter de poche, **corps en métal**
 Taschencutter, **Metallgehäuse**
 Cúter de bolsillo, **cuerpo metálico**

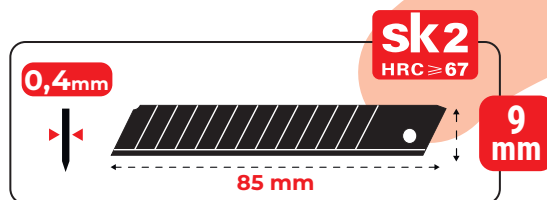

Ref.	H x L			H x L	
49066	140 x 15 mm	8001066490660	100	6 x 60 mm	<p>Stampa su etichetta in quadricromia <i>Four-colour label printing - Impression en quadrichromie sur étiquettes - Vierfarbendruck auf Etiketten - Impresión de la etiqueta en cuatricromía</i> oppure - or - ou - oder - o</p> <p>Stampa diretta massimo 1 colore - Direct printing maximum 1 color - Impression directe en 1 couleur maximum - Direktdruck maximal 1 Farbe - Impresión directa a 1 color como máximo</p>

MINI CUTTER CON CLIP

Cutter tascabile bloccalama
 Pocket cutter, safety lock
 Cutter de poche, blocage de sécurité
 Taschencutter, Sicherheits-Feststellung
 Cúter de bolsillo, freno de seguridad

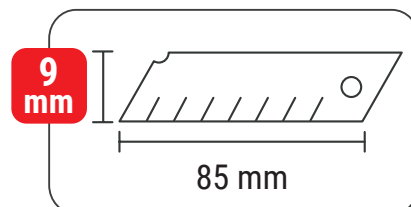

Ref.	H x L			H x L	
49017	135 x 15 mm	8001066490172	20	5 x 49 mm	<p>Stampa su etichetta in quadricromia <i>Four-colour label printing - Impression en quadrichromie sur étiquettes - Vierfarbendruck auf Etiketten - Impresión de la etiqueta en cuatricromía</i> oppure - or - ou - oder - o</p> <p>Stampa diretta massimo 1 colore - Direct printing maximum 1 color - Impression directe en 1 couleur maximum - Direktdruck maximal 1 Farbe - Impresión directa a 1 color como máximo</p>

RASCHIETTO

Raschietto multiuso lama retrattile
 Multipurpose scraper, retractable blade
 Grattoir multi-usage, lame rétractile
 Mehrfunktions-Kratzer, einziehbare
 Sicherheitsklinge
 Rascador multiuso, lama retractil

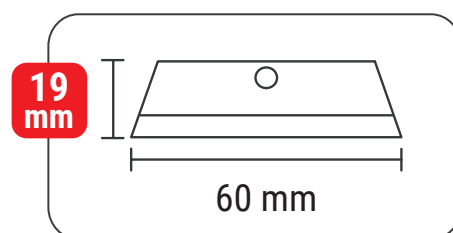

Ref.	H x L			H x L
49145	180 x 60 mm	8001066491452	10	18,5 x 74 mm <i>Stampa su etichetta in quadricromia</i> <i>Four-colour label printing - Impression en quadrichromie sur étiquettes - Vierfarbendruck auf Etiketten - Impresión de la etiqueta en cuatricromía</i>

APRI BUSTA

Apri busta
 Letter opener
 Ouvre-lettre
 Brieföffner
 Abre-sobre



Ref.	H x L			H x L
72180	44 x 75 mm	8001066721801	1	23 x 52 mm <i>Stampa su etichetta in quadricromia</i> <i>Four-colour label printing - Impression en quadrichromie sur étiquettes - Vierfarbendruck auf Etiketten - Impresión de la etiqueta en cuatricromía</i>





MATITONE

Matitone **38 cm**
 Big Pencil **38 cm**
 Crayon géant **38 cm**
 Großer Bleistift **38 cm**
 Lápiz grande **38 cm**



WITH CASE



Ref.	H x L			H x L	
51028 ○	38 x 375 mm	8001066510283	1	10 x 160 mm	<i>Stampa diretta massimo 1 colore - Direct printing maximum 1 color - Impression directe en 1 couleur maximum - Direktdruck maximal 1 Farbe - Impresión directa a 1 color como máximo</i>
51029 ●	38 x 375 mm	8001066510290	1	10 x 160 mm	

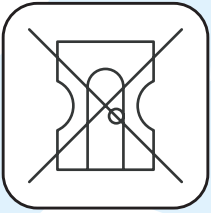
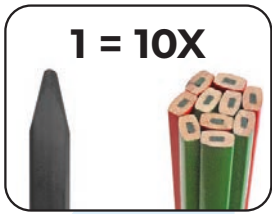

MATITA ALL SCRIPT 100% GRAFITE

Matita All script **100% grafite**, resistente agli urti e alle rotture, leggermente flessibile

All script pencil **100% graphite**, resistant to impact and breakage, slightly flexible

Crayon All script **100% graphite**, résistant aux chocs et à la casse, légèrement flexible

All script-Stift **100% Graphit**, schlag- und bruchfest, leicht flexibel

Lápiz All script **100% grafito**, resistente a los golpes y a la rotura, ligeramente flexible

All Script



Ferro

Iron
Fer
Eisen
Hierro



Legno

Wood
Bois
Holz
Madera



Metallo

Metal
Métal
Metall
Metal

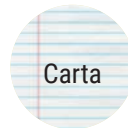

Carta

Papier
Papier
Papier
Papel



Cartone

Cardboard
Carton
Karton
Cartón



Ceramica

Ceramic
Cèramique
Keramik
Cerámica

Ref.	H x L			H x L	<i>Stampa diretta massimo 1 colore - Direct printing maximum 1 color - Impression directe en 1 couleur maximum - Direktdruck maximal 1 Farbe - Impresión directa a 1 color como máximo</i>
51150N	160 x 13 mm	8001066511501	12	7 x 100 mm	

MATITE FALEGNOME HIGH QUALITY



Matite falegname, **confezione da 144 pz**
 Carpenter pencils, **pack of 144 pcs**
 Crayons de charpentier, **paquet de 144 pcs**
 Zimmermannsbleistifte, **Packung mit 144 Stk**
 Lápizes de carpintero, **paquete de 144 pzs**



Ref.	L			H x L
51050N ●	180 mm	8001066510504	1	6 x 160 mm
51051N ●	180 mm	8001066510511	1	6 x 160 mm
51052N ●	180 mm	8001066510528	1	6 x 160 mm
51053N ○	180 mm	8001066510535	1	6 x 160 mm
51054N ●	180 mm	8001066510542	1	6 x 160 mm
51010N ●	240 mm	8001066510108	1	6 x 160 mm
51011N ●	240 mm	8001066510115	1	6 x 160 mm
51012N ○	240 mm	8001066510122	1	6 x 160 mm
51013N ●	240 mm	8001066510139	1	6 x 160 mm
51020N ●	300 mm	8001066510207	1	6 x 160 mm

Stampa diretta massimo 1 colore - Direct printing maximum 1 color - Impression directe en 1 couleur maximum - Direktdruck maximal 1 Farbe - Impresión directa a 1 color como máximo

MATITE MARMISTA HIGH QUALITY



Matite per marmista, **confezione da 144 pz**
 Marble pencil, **pack of 144 pcs**
 Crayons de maçon, **paquet de 144 pcs**
 Steinbleistifte, **Packung mit 144 Stk**
 Lapizes de marbolista, **paquete de 144 pzs**

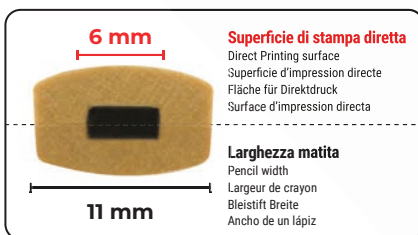

Ref.	L			H x L
51060N ●	240 mm	8001066510603	1	6 x 160 mm
51070N ●	300 mm	8001066510702	1	6 x 160 mm

Stampa diretta massimo 1 colore - Direct printing maximum 1 color - Impression directe en 1 couleur maximum - Direktdruck maximal 1 Farbe - Impresión directa a 1 color como máximo

MATITE FALEGNOME

Matite falegname, **confezione da 144 pz**
 Carpenter pencils, **pack of 144 pcs**
 Crayons de charpentier, **paquet de 144 pcs**
 Zimmermannsbleistifte, **Packung mit 144 Stk**
 Lápizes de carpintero, **paquete de 144 pzs**

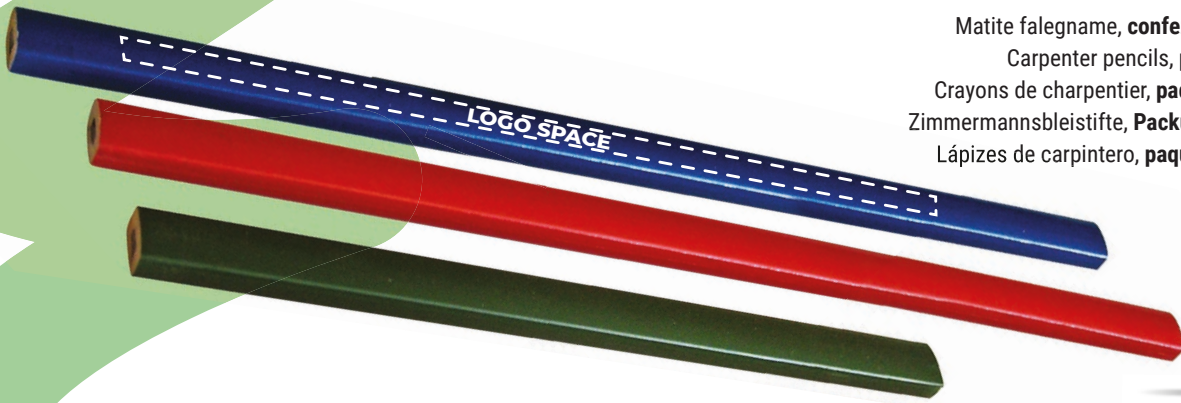

6 mm

Superficie di stampa diretta
 Direct Printing surface
 Surface d'impression directa
 Superficie d'impression directe
 Fläche für Direktdruck

Larghezza matita
 Pencil width - Ancho de un lápiz
 Largeur de crayon - Bleistift Breite

11 mm

Ref. 50419N - 50440N - 50441N - 50442N - 50451N - 50452N

5 mm

Superficie di stampa diretta
 Direct Printing surface
 Surface d'impression directa
 Superficie d'impression directe
 Fläche für Direktdruck

Larghezza matita
 Pencil width - Ancho de un lápiz
 Largeur de crayon - Bleistift Breite

12 mm

Ref. 51018N

Ref. 49159: Temperino non incluso - Pencil sharpener not included - Taille-crayon non inclus - Bleistiftspitzer nicht enthalten - Sacapuntas no incluido

Ref.	L			H x L
50419N ●	180 mm	8001066504190	1	6 x 160 mm
50440N ●	180 mm	8001066504404	1	6 x 160 mm
50441N ○	180 mm	8001066504411	1	6 x 160 mm
50442N ●	180 mm	8001066504428	1	6 x 160 mm
50451N ○	250 mm	8001066504510	1	6 x 160 mm
50452N ●	250 mm	8001066504527	1	6 x 160 mm
51018N ●	250 mm	8001066510184	1	5 x 160 mm

Stampa diretta massimo 1 colore - Direct printing maximum 1 color - Impression directe en 1 couleur maximum - Direktdruck maximal 1 Farbe - Impresión directa a 1 color como máximo

MATITE MARMISTA

Matite per marmista, **confezione da 144 pz**
 Marble pencil, **pack of 144 pcs**
 Crayons de maçon, **paquet de 144 pcs**
 Steinbleistifte, **Packung mit 144 Stk**
 Lapizes de marbolista, **paquete de 144 pzs**

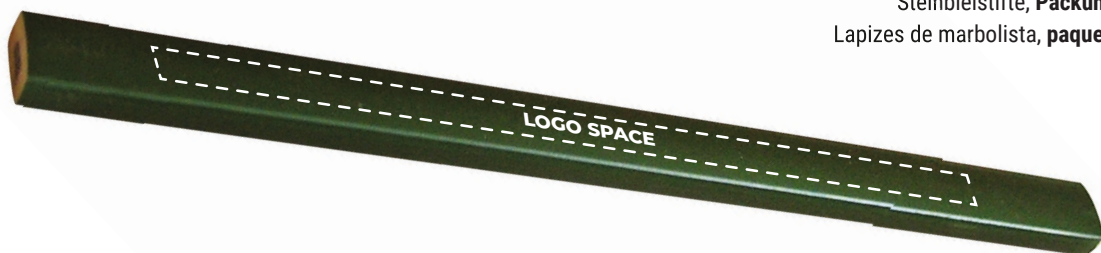

6 mm

Superficie di stampa diretta
 Direct Printing surface
 Surface d'impression directa
 Superficie d'impression directe
 Fläche für Direktdruck

Larghezza matita
 Pencil width
 Largeur de crayon
 Bleistift Breite
 Ancho de un lápiz

11 mm

Ref. 49159: Temperino non incluso - Pencil sharpener not included - Taille-crayon non inclus - Bleistiftspitzer nicht enthalten - Sacapuntas no incluido

Ref.	L			H x L
51060ANN ●	240 mm	8001066510603	1	6 x 160 mm

Stampa diretta massimo 1 colore - Direct printing maximum 1 color - Impression directe en 1 couleur maximum - Direktdruck maximal 1 Farbe - Impresión directa a 1 color como máximo

MATITA DA CARPENTIERE

Matita da carpentiere, mina nera, **corpo in ABS**, temperino e portamine interno
 Carpenter's pencil, black lead, **ABS body**, sharpener and internal pencil holder
 Crayon de charpentier, mine noire, **corps en ABS**, taille-crayon et porte-crayon interne
 Zimmermannsbleistift, schwarze Mine, **ABS-Körper**, Spitzer und interner Bleistifthalter
 Lápiz de carpintero, mina negra, **cuerpo ABS**, sacapuntas y portalápices interno

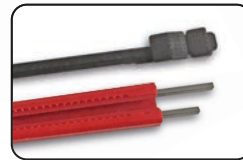

Ref.	L			H x L	
51105N	180 mm	8001066511051	10	7 x 45 mm	<i>Stampa diretta massimo 1 colore - Direct printing maximum 1 color - Impression directe en 1 couleur maximum - Direktdruck maximal 1 Farbe - Impresión directa a 1 color como máximo</i>

MATITE NATURALI

Matite naturali, **confezione da 144 pz**
 Natural pencils, **pack of 144 pcs**
 Crayons naturels, **paquet de 144 pcs**
 Naturbleistifte, **Packung mit 144 Stk**
 Lápices naturales, **paquete de 144 pzs**



Ref.	L			H x L	
51510N ○	80 mm	8001066551514	1	2 x 40 mm	<i>Stampa diretta massimo 1 colore - Direct printing maximum 1 color - Impression directe en 1 couleur maximum - Direktdruck maximal 1 Farbe - Impresión directa a 1 color como máximo</i>

MATITA CORPO IN ABS

Corpo in **ABS rubber touch**,
mina nera gigante Ø 5mm ABS
Body **rubber touch**, giant mine Ø 5mm
Corps en **ABS rubber touch**,
grande mine noire Ø 5mm
ABS - Gehäuse rubber touch,
schwarze Riesenmine
Cuerpo de **ABS rubber touch**, mina negra Ø 5mm

Ref. 01090: Mine di ricambio - Spare mine -
Mine de rechange - Ersatzmine - Mina de recambio



Ref.

51089

L

140 mm



8001066510894



1

H x L

3 x 60 mm

Stampa diretta massimo 1 colore - Direct printing maximum 1
color - Impression directe en 1 couleur maximum - Direktdruck
maximal 1 Farbe - Impresión directa a 1 color como máximo

MATITA CORPO IN BACHELITE

Corpo in **bachelite** con pulsante in metallo,
mina nera gigante Ø 5 mm
Black **bakelite body**, metallic button giant
mine Ø 5 mm
Corps **noir en bakélite**, bouton métallique,
grande mine noire Ø 5 mm
Körper aus **schwarzem Bakelit**, Metall,
Druckknopf - Große schwarze Mine Ø 5 mm
Cuerpo **negro baquelita**, botón de metal,
mina negra gigante Ø 5 mm

Ref. 01090: Mine di ricambio - Spare mine - Mine
de rechange - Ersatzmine - Mina de recambio



Ref.

51080

L

140 mm



8001066510801



1

H x L



6 x 50 mm

Stampa diretta massimo 1 colore - Direct printing maximum 1
color - Impression directe en 1 couleur maximum - Direktdruck
maximal 1 Farbe - Impresión directa a 1 color como máximo

LIVELLA 2 FIALE

Livella - 2 fiale
Level - 2 vials
Niveau - 2 fioles
Wasserwaage - 2 Libellen
Nivel - 2 burbujas





Ref.	L			H x L
32543N	300 mm	8001066325436	6	150 x 22 mm
32544N	400 mm	8001066325443	6	150 x 22 mm
32545N	500 mm	8001066325450	6	150 x 22 mm

Stampa diretta massimo 1 colore - Direct printing maximum 1 color - Impression directe en 1 couleur maximum - Direktdruck maximal 1 Farbe - Impresión directa a 1 color como máximo

MINILIVELLA TASCABILE

Minilivella tascabile a 1 fiala, **10 cm**
Mini pocket-level with 1 vial, **10 cm**
Mini-niveau de poche avec 1 fiole, **10 cm**
Mini Taschen-Wasserwaage mit 1 Libelle, **10 cm**
Mini nivel con 1 burbuja, **10 cm**



Ref.	L			H x L
31021N	100 mm	8001066310210	1	5 x 90 mm



Stampa diretta massimo 1 colore - Direct printing maximum 1 color - Impression directe en 1 couleur maximum - Direktdruck maximal 1 Farbe - Impresión directa a 1 color como máximo

NEW



LIVELLA PER ELETTRICISTI 20CM

Livella due fiale, **anodizzata nera**, disponibile anche in **versione magnetica con magnete invisibile, 20 cm, base fresata**
Two vial spirit level, **black anodised**, also **available in magnetic version with invisible magnet, 20 cm, milled base**
Niveau à bulle à deux fioles, **noir anodisé**, également disponible en **version magnétique avec aimant invisible, 20 cm, base fraisée**
Wasserwaage mit zwei Libellen, **schwarz eloxiert**, auch in magnetischer Ausführung mit unsichtbarem
Magneten erhältlich, 20 cm, gefräste Basis
Nivel con 2 burbujas, **anodizado negro**, también disponible en **versión magnética con imán invisible, 20 cm, base fresada**

Ref.	L			H x L	
31028N	200 mm	8001066310289	1	10 x 100 mm	<i>Stampa diretta massimo 1 colore - Direct printing maximum 1 color - Impression directe en 1 couleur maximum - Direktdruck maximal 1 Farbe - Impresión directa a 1 color como máximo</i>
31029N 	200 mm	8001066310296	1	10 x 100 mm	

LIVELLA PLEXIGLASS TRASPARENTE

Livella **plexiglass trasparente** a 2 fiale, 100 mm x 51 mm
 Transparent **Plexiglass level** with 2 vials, 100 mm x 51 mm
 Niveau en **plexiglas transparent** avec 2 fioles, 100 mm x 51 mm
Plexiglas-Wasserwaage, durchsichtig, mit 2 Libellen, 100 mm x 51 mm
 Nivel de **plexiglás transparente** con 2 burbujas, 100 mm x 51 mm



Ref.	H x L			H x L	
33036N	51 x 100 mm	8001066330362	1	15 x 60 mm	<i>Stampa diretta massimo 1 colore - Direct printing maximum 1 color - Impression directe en 1 couleur maximum - Direktdruck maximal 1 Farbe - Impresión directa a 1 color como máximo</i>
33037N	51 x 100 mm	8001066330379	1	35 x 25 mm	

LIVELLA TASCABILE ABS

Livella tascabile ABS - 2 fiale
 Pocket ABS level - 2 vials
 Niveau de poche en ABS - 2 fioles
 Taschen ABS-Wasserwaage - 2 Libellen
 Nivel de bolsillo de ABS - 2 burbujas



Ref.	L			H x L	
33090	105 mm	8001066330904	10	10 x 75 mm	<i>Stampa diretta massimo 1 colore - Direct printing maximum 1 color - Impression directe en 1 couleur maximum - Direktdruck maximal 1 Farbe - Impresión directa a 1 color como máximo</i>
33091	105 mm	8001066330911	10	10 x 75 mm	
33092	105 mm	8001066330928	10	10 x 75 mm	
33093	105 mm	8001066330935	10	10 x 75 mm	
33094	105 mm	8001066330942	10	10 x 75 mm	

ROTELLE NASTRO IN FIBRA DI VETRO

Nastro in fibra di vetro - grad. cm - cassa ABS - manovella in metallo
 Fiberglass long tape rule - grad. cm - ABS case metal rewinding handle
 Ruban en fibre de verre - grad. cm - boîtier en ABS - manivelle en métal
 Glasfaserbandmaße - Teil. cm - ABS - Kapsel - Metallkurbel
 Cinta de fibra de vidrio - grad. cm - caja de ABS - manivel de metal

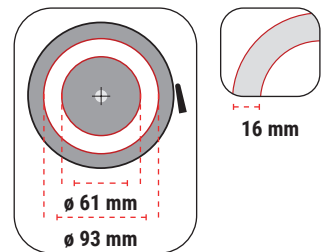

Ref.	L				Ø
40016SP	10 m	16 mm	8001066400164	1	93 mm
40017SP	20 m	16 mm	8001066400171	1	93 mm

Stampa su etichetta in quadricromia
 Four-colour label printing - Impression en quadrichromie sur étiquettes - Vierfarbendruck auf Etiketten - Impresión de la etiqueta en cuatricromía

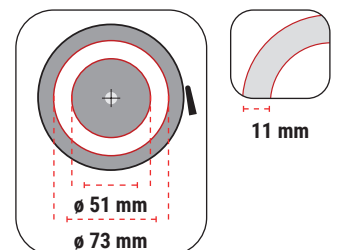

Ref.	L				Ø
40011SP	10 m	16 mm	8001066400119	5	73 mm
40013SP	20 m	16 mm	8001066400133	5	73 mm

Stampa su etichetta in quadricromia
 Four-colour label printing - Impression en quadrichromie sur étiquettes - Vierfarbendruck auf Etiketten - Impresión de la etiqueta en cuatricromía

FIBRA DI VETRO

Fibra di vetro - grad. cm, custodia in metallo rivestita in skay
Fiberglass tape - grad. cm - metal case yellow similar leather covered
Fibre de verre - grad. cm - boîtier jaune en métal revêtu en simil-cuir
Glasfaserbandmaße - Teil. cm - Kunstleder, Käpselüberzug- gelb
Fibra de vidrio - grad. cm - caja amarillo de metal cubierta en simil-cuero

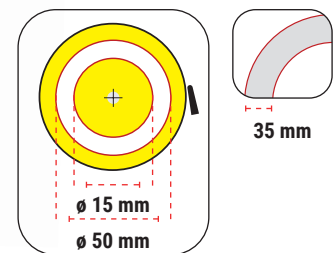
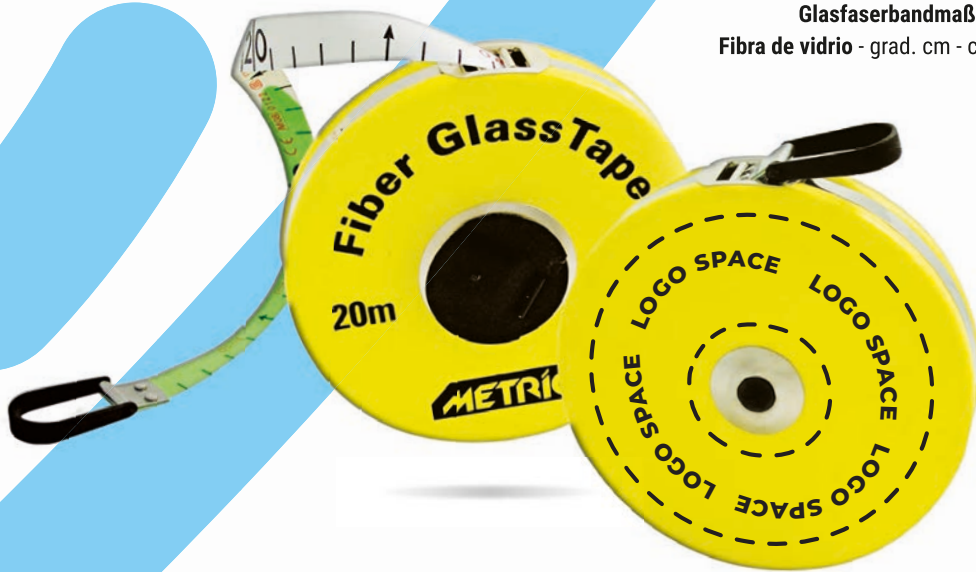

Ref.	L				Ø
40143SP	20 m	16 mm	8001066401437	1	50 mm

Stampa diretta massimo 1 colore - Direct printing maximum 1 color - Impression directe en 1 couleur maximum - Direktdruck maximal 1 Farbe - Impresión directa a 1 color como máximo

CALIBRI IN PLASTICA

Calibro in plastica - **lettura 1/10 mm**
 ABS vernier caliper - **reading 1/10 mm**
 Pied à coulisse en ABS - **lecture 1/10 mm**
 ABS-Messschieber - **Ablesung 1/10 mm**
 Calibre de ABS - **lectura 1/10 mm**

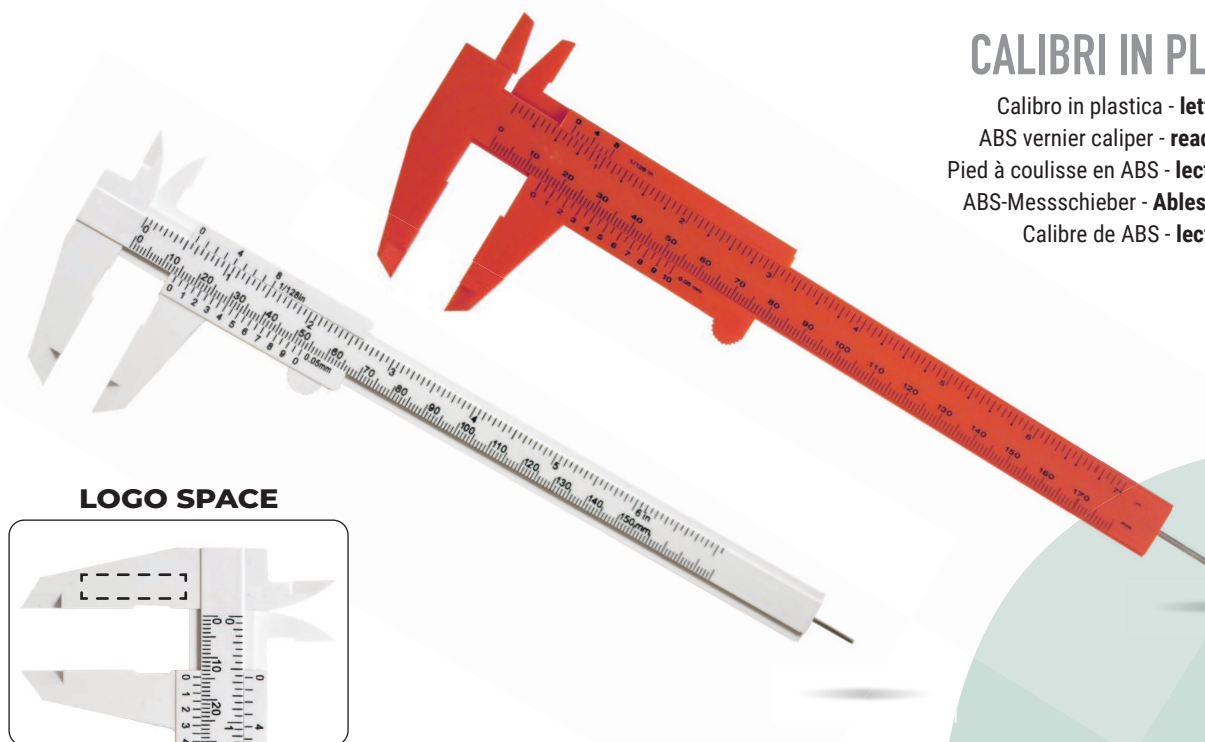

LOGO SPACE

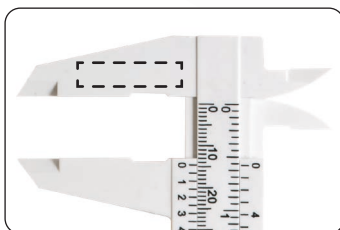

Ref.	mm			H x L
10723 ●	0 - 150	8001066107230	10	6 x 25 mm
10722 ○	0 - 150	8001066107223	10	6 x 25 mm

Incisione laser - Laser printing - Impresión láser - Laserdruck - Impression laser
 oppure - or - ou - oder - o
Stampa diretta massimo 1 colore - Direct printing maximum 1 color - Impression directe en 1 couleur maximum - Direktdruck maximal 1 Farbe - Impresión directa a 1 color como máximo

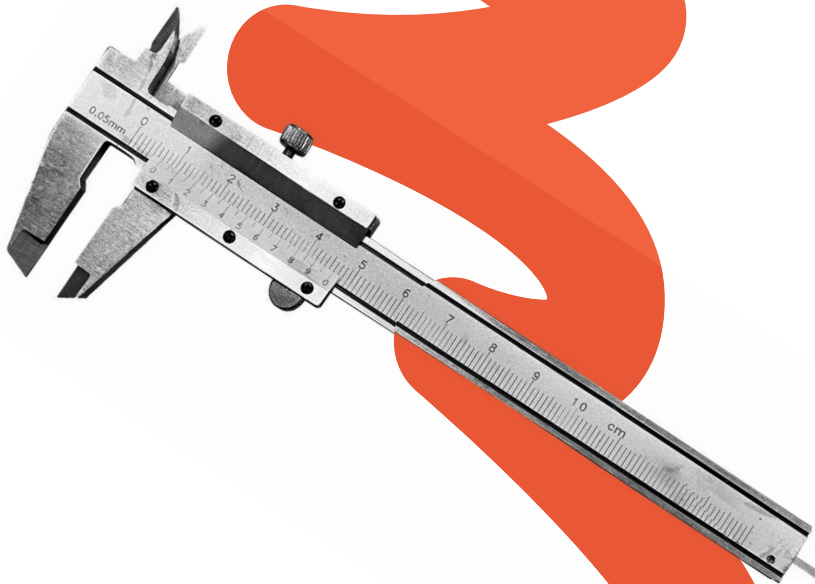

CALIBRI TASCABILI

Calibro tascabile - in acciaio - lettura 1/20 mm
 Pocket vernier caliper - reading 1/20 mm
 Pied à coulisse de poche - lecture 1/20 mm
 Taschen-Messschieber - Ablesung 1/20 mm
 Calibre de bolsillo - lectura 1/20 mm



LOGO SPACE



Ref.	mm			H x L
10011N	0 - 97	8001066100118	5	6 x 30 mm <i>Incisione laser - Laser printing - Impresión láser Impression laser - Laserdruck</i>

CALIBRI TASCABILI

Calibro speciale per bottoni in ottone
 Special caliper for brass buttons
 Calibre spécial pour les boutons en laiton
 Speziallehre für Messingknöpfe
 Calibre especial para botones de latón

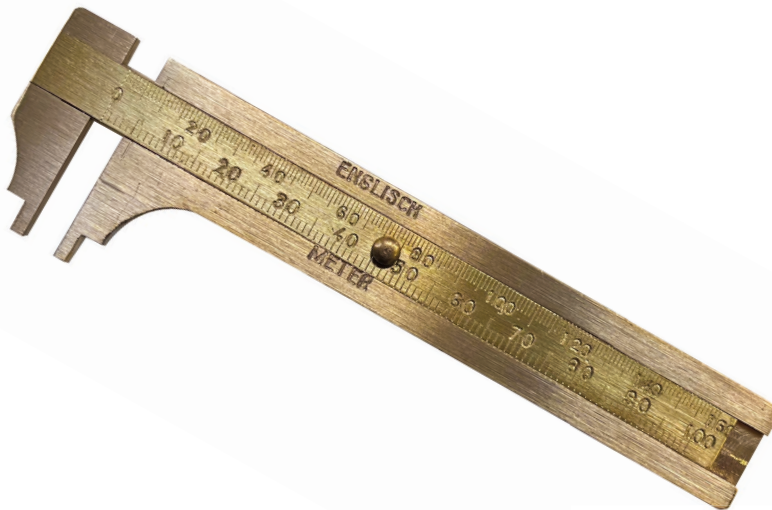

LOGO SPACE



Ref.	mm			H x L
10801	0 - 95	8001066108015	5	6 x 10 mm <i>Incisione laser - Laser printing - Impresión láser Impression laser - Laserdruck</i>

CRISTALLO OTTICO DA TAVOLO

Cristallo ottico da tavolo con led manico gommato
 Crystal lens with led
 Lentille en cristal avec lumière
 Kristall-Lupe mit LED-Leuchte u. gummiertem Griff
 Lente de cristal con led



2X

Ref.	Ø				H x L	
49492	90 mm	2 x	8001066494927	2	6 x 20 mm	<i>Stampa diretta massimo 1 colore - Direct printing maximum 1 color - Impression directe en 1 couleur maximum - Direktdruck maximal 1 Farbe - Impresión directa a 1 color como máximo</i>
49494	110 mm	2 x	8001066494941	2	6 x 20 mm	

LENTE BIFOCALE

Lente acrilica bifocale **ingrandimento 2,5X - 5X**
 Bifocal magnifier - acrylic lens - **magnification 2,5X - 5X**
 Loupe bifocale - lentille acrylique - **grossissement 2,5X - 5X**
 Bifokal-Lupe - Acryl-Linse - **Vergrößerung 2,5X - 5X**
 Lupa bifocal - lente acrilico - **aumento 2,5X - 5X**



5X

2,5X



Ø12mm

Ref.	Ø				H x L	
49498	75 mm	2,5x - 5x	8001066494989	1	4 x 50 mm	<i>Stampa diretta massimo 1 colore - Direct printing maximum 1 color - Impression directe en 1 couleur maximum - Direktdruck maximal 1 Farbe - Impresión directa a 1 color como máximo</i>

CRISTALLO OTTICO

Cristallo ottico - custodia in semipelle
 Cristal lens - similar leather
 Lentille en cristal - simil-cuir
 Kristall-Taschenlupe, Etui aus Kunstleder
 Lente de cristal - simil cuero



Ref.	Ø				Ø
49510	50 mm	3,5x	8001066495108	1	35 mm

Stampa diretta massimo 1 colore - Direct printing maximum 1 color - Impression directe en 1 couleur maximum - Direktdruck maximal 1 Farbe - Impresión directa a 1 color como máximo

CONTAFILI A LIBRO PLASTICA

Contafili a libro in **ABS** nero
 Foldable linen **ABS**
 Compte-fils - **ABS** noir
 Ausklappbarer Fadenzähler - **ABS**
 Cuenta-hilos - **ABS** negro

6X

49585



8X

49550



Ref.	mm				H x L
49550	21 x 21	8x	8001066495504	2	15 x 15 mm
49585	20 x 20	6x	8001066495856	2	10 x 10 mm

Stampa su etichetta in quadricromia
 Four-colour label printing - Impression en quadrichromie sur étiquettes - Vierfarbendruck auf Etiketten - Impresión de la etiqueta en cuatricromía
 oppure - or - ou - oder - o

Stampa diretta massimo 1 colore - Direct printing maximum 1 color - Impression directe en 1 couleur maximum - Direktdruck maximal 1 Farbe - Impresión directa a 1 color como máximo



MINI 2M

Flessometro **cassa in ABS**, nastro bianco, colori assortiti

ABS case, white tape, mixed colours

Boîtier ABS, ruban blanc, couleurs panachées

ABS-Gehäuse, weißes Band, panaschierte Farben

Estuche de ABS, cinta blanca, colores mixtos



Ref.				Ø	
98028 ○	2 m x 13 mm	8001066980284	12	29 mm	Stampa su etichetta in quadricromia Four-colour label printing - Impression en quadrichromie sur étiquettes - Vierfarbendruck auf Etiketten - Impresión de la etiqueta en cuatricromía
98029 ●	2 m x 13 mm	8001066980291	12	29 mm	
98030 ●	2 m x 13 mm	8001066980307	12	29 mm	



MINI 2M TRANSPARENT

Nastro bianco, colori assortiti, doppia graduazione (orizzontale + verticale) - **Cassa Trasparente**

White tape, mixed colours, double graduation (horizontal + vertical) - **Transparent case**

Ruban blanc, couleurs panachées, double graduation (horizontale + verticale) - **Boîtier transparent**

Weißes Band, gemischte Farben, doppelte Teilung (waagrecht + senkrecht) - **Durchsichtige Kapsel**

Graduación doble (horizontal + vertical) - **Estuche transparente**



Ref.			
98031		8001066980314	12
98032		8001066980321	12
98033		8001066980338	12

H x L

23 x 31 mm
23 x 31 mm
23 x 31 mm

Stampa su etichetta in quadricromia

Four-colour label printing - Impression en quadrichromie sur étiquettes - Vierfarbendruck auf Etiketten - Impresión de la etiqueta en cuatricromía oppure - or - ou - oder - o

Stampa diretta massimo 1 colore - Direct printing maximum 1 color - Impression directe en 1 couleur maximum - Direktdruck maximal 1 Farbe - Impresión directa a 1 color como máximo

PORTACHIAVI

Portachiavi minilivella con fiola
 Key-holder levels
 Porte-clès mini niveaux
 Schlüsselanhänger mini-Wasserwaage
 Lavero mini nivele



Ref.	L mm			H x L	<i>Stampa diretta massimo 1 colore - Direct printing maximum 1 color - Impression directe en 1 couleur maximum - Direktdruck maximal 1 Farbe - Impresión directa a 1 color como máximo</i>
33015 ●	40 mm	8001066330157	10	7 x 25 mm	

PORTACHIAVI

Flessometro portachiavi 2m
 Keychain tape rule 2m
 Metrè porte-clés flexomètre 2m
 Schlüsselanhänger-Bandmaß 2m
 Flexómetro llavero 2m

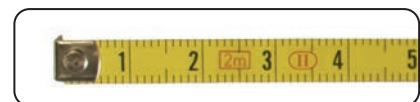





Ref.				H x L	<i>Stampa diretta massimo 1 colore - Direct printing maximum 1 color - Impression directe en 1 couleur maximum - Direktdruck maximal 1 Farbe - Impresión directa a 1 color como máximo</i>
38045	2 m x 6 mm	8001066380459	10	30 x 30 mm	

PORTACHIAVI

Portachiavi **0,5m**, fibra di vetro
 Key ring **0,5m**, fibreglas
 Porte-clés **0,5m**, fibre de verre
 Schlüsselanhänger **0,5m**, Glasfaser
 Llaveru **0,5m**, fibra de vidrio





Ref.	L mm			H x L	
18800N 	50	8001066188000	10	14 x 43 mm	<i>Stampa diretta massimo 1 colore - Direct printing maximum 1 color - Impression directe en 1 couleur maximum - Direktdruck maximal 1 Farbe - Impresión directa a 1 color como máximo</i>
18802N 	50	8001066188024	10	14 x 43 mm	

PORTACHIAVI

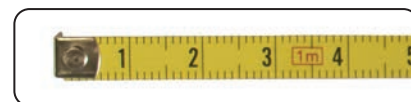
Flessometro portachiavi **1m**
 Keychain tape rule **1m**
 Metrè porte-clés flexomètre **1m**
 Schlüsselanhänger-Bandmaß **1m**
 Flexómetro llaveru **1m**



Ref.				Ø	
38008N	1 m x 6 mm	8001066380084	10	21 mm	<i>Stampa diretta massimo 1 colore - Direct printing maximum 1 color - Impression directe en 1 couleur maximum - Direktdruck maximal 1 Farbe - Impresión directa a 1 color como máximo</i>

MISURATORE DI SPESSORE

Misuratore di spessore **lettura 0,1mm**
 Dial thickness gauge, **reading 0,1mm**
 Jauge d'épaisseur à cadran, **lecture 0,1mm**
 Dickenmeßgerät, **Ablesung 0,1mm**
 Medidor de espesor de cuadrante, **lect. 0,1mm**



LOGO SPACE



Ref.

A x B



H x L

43052N
43053N

20 x 20 mm
20 x 50 mm

8001066430529
8001066430536

1
1

7 x 21 mm
7 x 21 mm

Stampa diretta sul quadrante massimo 1 colore
 Direct printing on the quadrant maximum 1 color
 - Impression directe sur le cadran max. 1 couleur -
 Direktdruck auf Zifferblatt max. 1 Farbe - Impresión
 directa en la esfera máx. 1 color

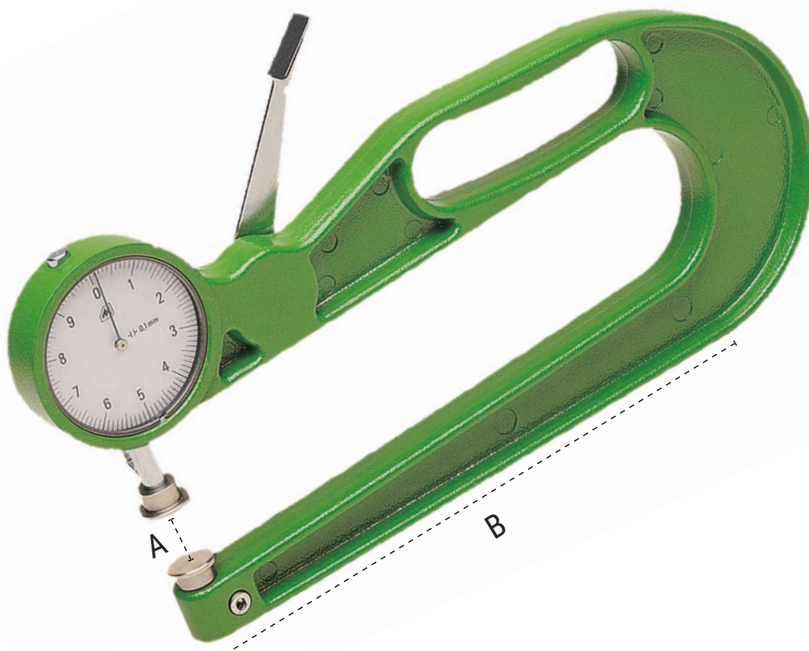

MISURATORE DI SPESSORE A QUADRANTE

Misuratore di spessore a quadrante
 con leva **lett. 0,1mm**
 Dial thickness gauge, **reading 0,1mm** lifting lever
 Jauge d'épaisseur à cadran,
lecture 0,1mm avec levier
 Uhr-Dickenmeßgerät,
Ablesung 0,1mm Abhebevorrichtung
 Medidor de espesor de cuadrante decimal, **lect. 0,1mm**

LOGO SPACE



Ref.

A x B



H x L

43055N
43056N

30 x 200 mm
30 x 300 mm

8001066430550
8001066430567

1
1



7 x 21 mm
7 x 21 mm

Stampa diretta sul quadrante massimo 1 colore
 Direct printing on the quadrant maximum 1 color
 - Impression directe sur le cadran max. 1 couleur -
 Direktdruck auf Zifferblatt max. 1 Farbe - Impresión
 directa en la esfera máx. 1 color

MISURATORI DI PROFONDITÀ

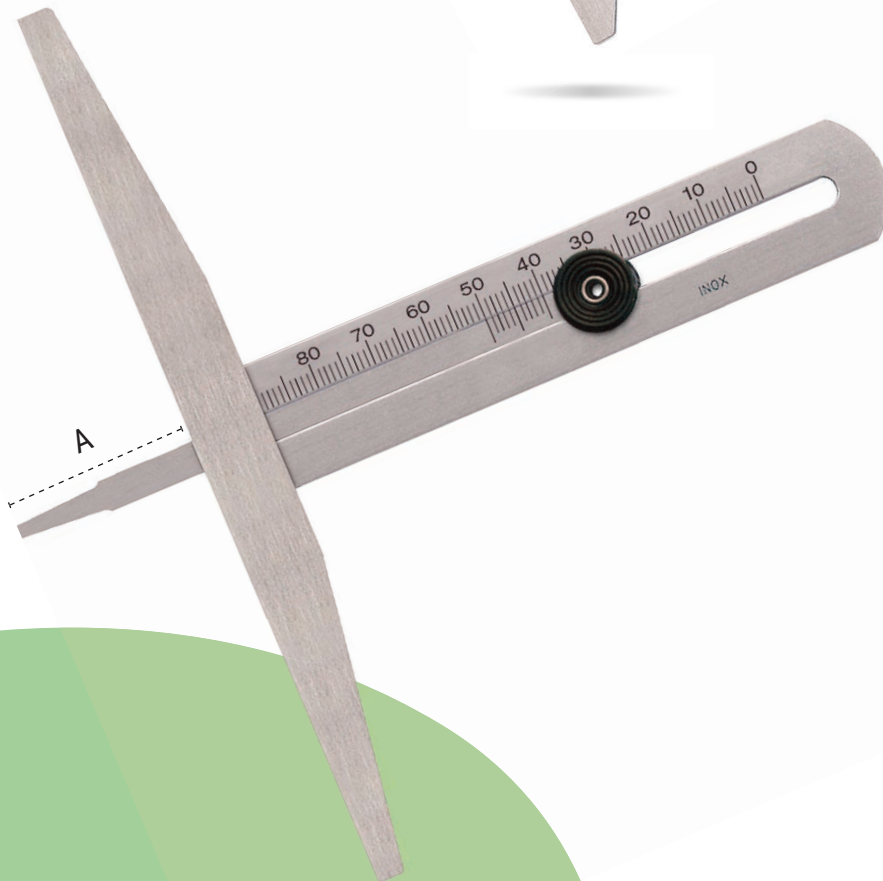
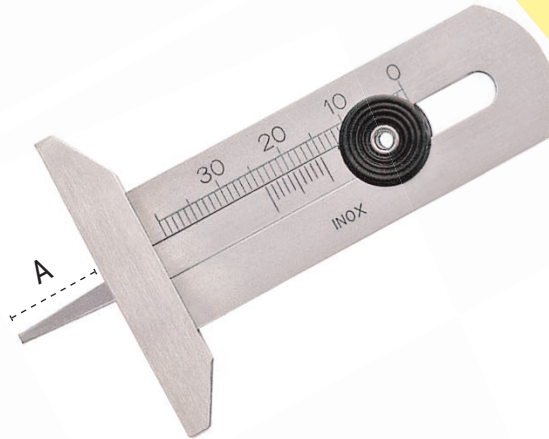
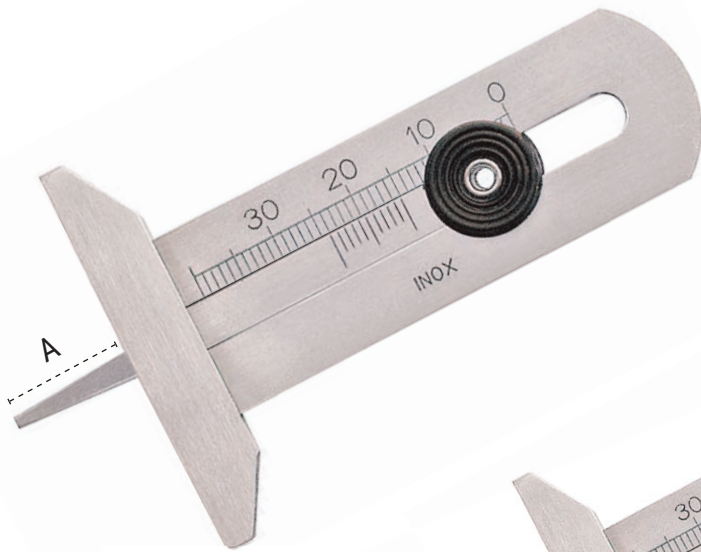
Misuratore di profondità per battistrada - acciaio inox
 Tyre profile depth gauge - stainless steel
 Jauge de profondeur pour pneus - acier inox
 Reifenprofilmesser - rostfreier Stahl
 Medidor de profundidad para neumáticos - acero inox



Ref.	A			H x L	
10820	0 - 30 mm	8001066108206	1	45 x 2,5 mm	<i>Incisione laser - Laser printing - Impresión láser Impression laser - Laserdruck</i>
10821	0 - 50 mm	8001066108213	1	30 x 4,5 mm	
10822	0 - 90 mm	8001066108220	1	70 x 5 mm	

MISURATORE PROFONDITÀ BATTISTRADA

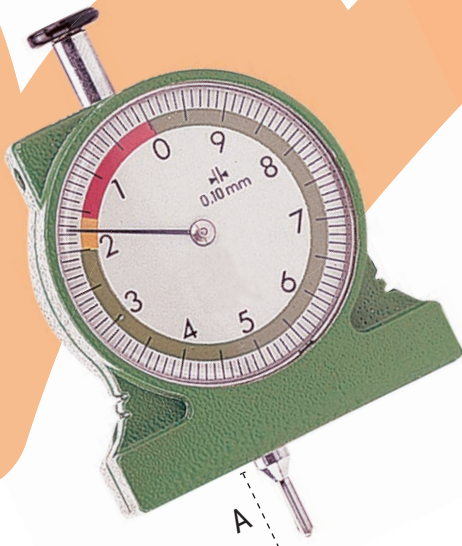

Misuratore profondità battistrada **lettura 0,1mm**
 Dial depth gauge for tyres, **reading 0,1mm**
 Jauge de profondeur à cadran pour pneus, **lecture 0,1mm**
 Reifen-Uhrmeßgerät, **Ablesung 0,1mm**
 Medidor de espesor de cuadrante para neumáticos, **lect. 0,1mm**

LOGO SPACE

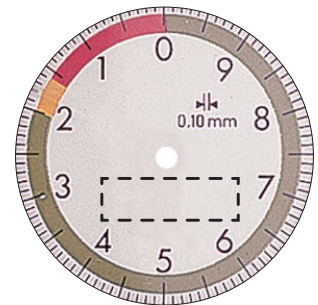
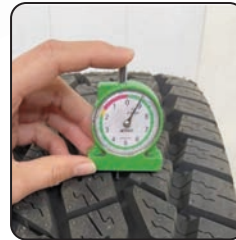

Ref.	A			H x L
43140	0 - 20 mm	8001066431403	1	7 x 21 mm <i>Stampa diretta massimo 1 colore - Direct printing maximum 1 color - Impression directe en 1 couleur maximum - Direktdruck maximal 1 Farbe - Impresión directa a 1 color como máximo</i>

MISURATORE DI SPESSORE A PINZA

Misuratore di spessore a pinza analogico, **lettura 0,2 mm**
 Analog caliper thickness gauge, **reading 0,2 mm**
 Pied à coulisse analogique pour mesurer l'épaisseur, **lecture 0,2 mm**
 Analoger Dickenmessschieber, **Ablesung 0,2 mm**
 Medidor de espesor de calibre analógico, **lectura de 0,2 mm**



LOGO SPACE



Ref.	A			H x L
70200	0 - 40 mm	8001066702008	1	7 x 21 mm <i>Stampa su etichetta in quadricromia</i>
70209	0 - 80 mm	8001066702091	1	7 x 21 mm <i>Four-colour label printing - Impression en quadrichromie sur étiquettes - Vierfarbendruck auf Etiketten - Impresión de la etiqueta en cuatricromía</i>

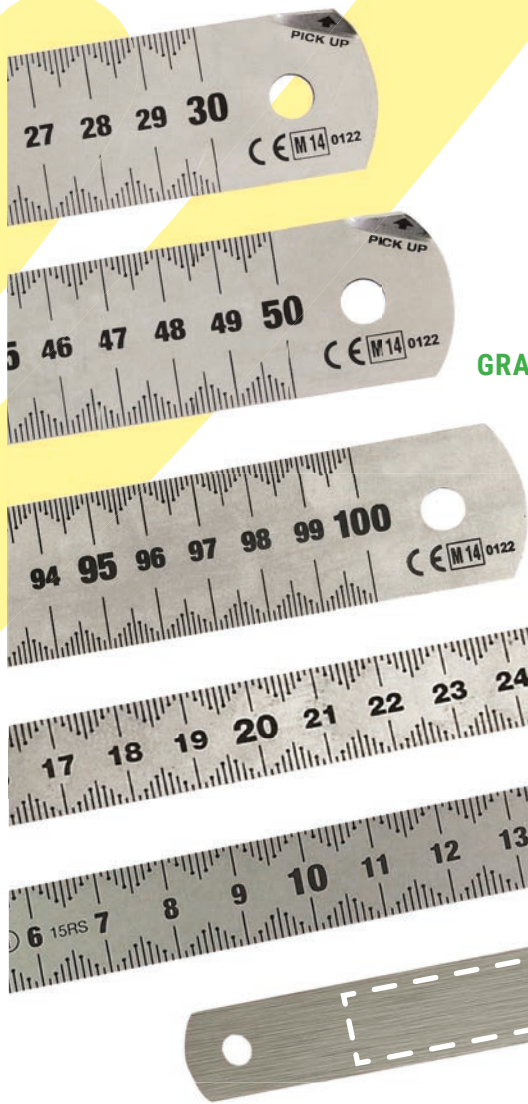

OTHER MODELS



NEW GRADUATION



EASY READING GRADUATION RIGA ACCIAIO INOX

Riga acciaio inox con **graduazione a lettura facilitata**
 Stainless steel rule with **graduation for easy reading**
 Règle acier inox avec **graduazione pour lecture facilitée**
 Maßstab, rostfreier Stahl mit **Teilung für vereinfachtes Ablesen**
 Regla acero inox con **graduación a lectura simplificada**



Ref.	LxHxP			H x L	
24300	150 x 15 x 0,5 mm	8001066243006	1	10 x 190 mm	Stampa diretta massimo 1 colore - Direct printing maximum 1 color - Impression directe en 1 couleur maximum - Direktdruck maximal 1 Farbe - Impresión directa a 1 color como máximo
24301	200 x 15 x 0,5 mm	8001066243013	1	10 x 190 mm	
24303	300 x 15 x 0,5 mm	8001066243037	1	10 x 190 mm	
24320	300 x 30 x 1 mm	8001066243204	1	20 x 190 mm	oppure - or - ou - oder - o
24321	500 x 30 x 1 mm	8001066243211	1	20 x 190 mm	Incisione laser - Laser printing - Impresión láser - Laserdruck - Impression laser
24322	1000 x 30 x 1 mm	8001066243228	1	20 x 190 mm	

RIGHE ACCIAIO INOX 20 X 0,5 MM

Righe in acciaio inox
Stainless steel rule
Règle acier inox
Maßstab, rostfreier Stahl
Regla acero inox

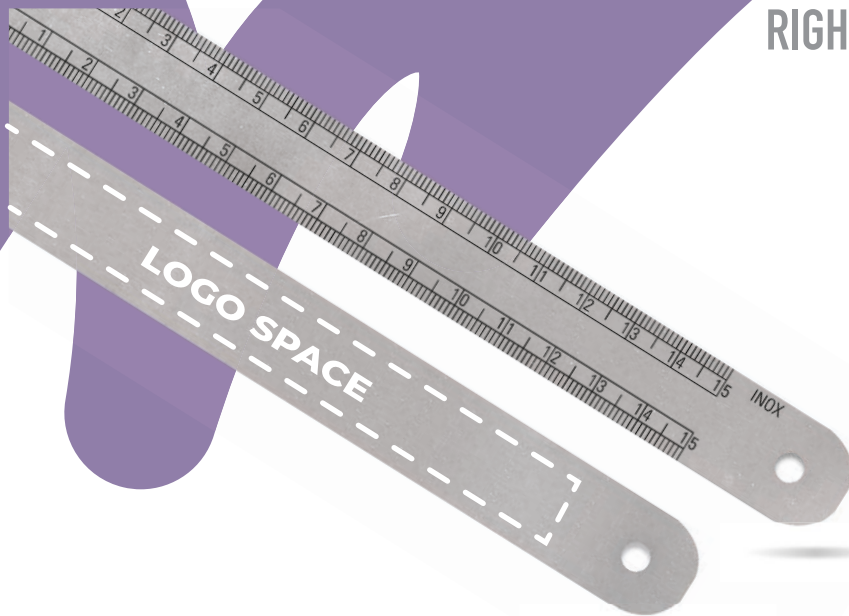

Su richiesta disponibili in
differenti misure e graduazioni

On demande, different sizes and graduations available
A demanda hay otras medidas y graduaciones
Sur demande d'autres longueurs
et graduations sont disponibles
Auf Anfrage sind andere Längen
und Teilungen verfügbar

Ref.	LxHxP			H x L
24070	150 x 20 x 0,5 mm	8001066240708	1	15 x 220 mm
24072	500 x 20 x 0,5 mm	8001066240722	1	15 x 220 mm
24075	500 x 20 x 0,5 mm/1/2mm	8001066240753	1	15 x 220 mm
24092	500 x 20 x 0,5 mm/inch	8001066240920	1	15 x 220 mm

Stampa diretta massimo 1 colore - Direct printing maximum 1 color - Impression directe en 1 couleur maximum - Direktdruck maximal 1 Farbe - Impresión directa a 1 color como máximo
oppure - or - ou - oder - o

Incisione laser - Laser printing - Impresión láser - Laserdruck - Impression laser

RIGHE ACCIAIO INOX 13 X 0,4 MM

Righe in acciaio inox
Stainless steel rule
Règle acier inox
Maßstab, rostfreier Stahl
Regla acero inox

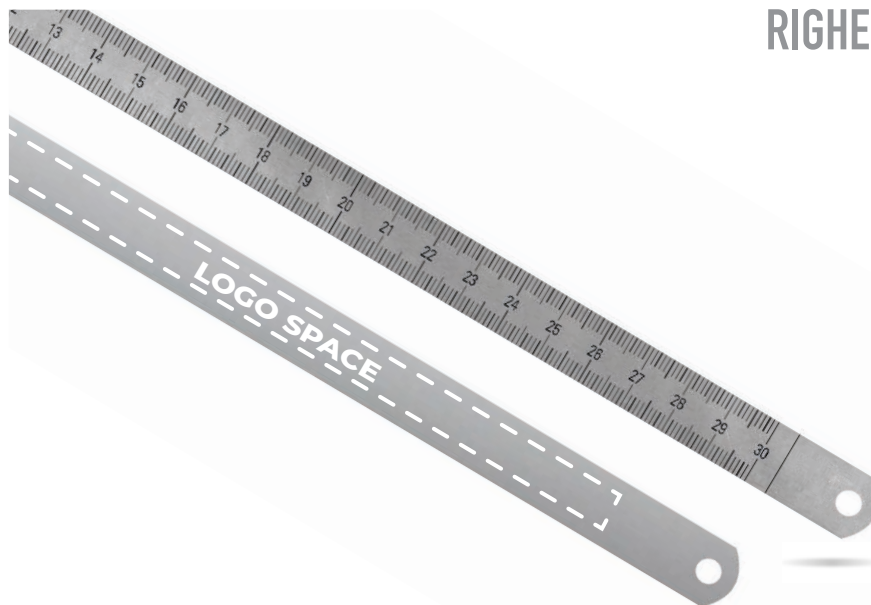

Su richiesta disponibili in
differenti misure e graduazioni

On demande, different sizes and graduations available
A demanda hay otras medidas y graduaciones
Sur demande d'autres longueurs
et graduations sont disponibles
Auf Anfrage sind andere Längen
und Teilungen verfügbar

Ref.	LxHxP			H x L
24052	200 x 13 x 0,4 mm	8001066240524	5	15 x 220 mm
24054	300 x 13 x 0,4 mm	8001066240548	5	15 x 220 mm
24032	200 x 13 x 0,4 mm/1/2mm	8001066240326	5	15 x 220 mm
24034	300 x 13 x 0,4 mm/1/2mm	8001066240340	5	15 x 220 mm
24012	200 x 13 x 0,4 mm/inch	8001066240128	5	15 x 220 mm
24014	300 x 13 x 0,4 mm/inch	8001066240142	5	15 x 220 mm

Stampa diretta massimo 1 colore - Direct printing maximum 1 color - Impression directe en 1 couleur maximum - Direktdruck maximal 1 Farbe - Impresión directa a 1 color como máximo
oppure - or - ou - oder - o

Incisione laser - Laser printing - Impresión láser - Laserdruck - Impression laser

TIPOMETRO ACCIAIO INOX 20 X 0,5 MM

Tipometro acciaio inox - 4 scale
 Stainless steel typescale - 4 scale
 Règle pour imprimeur en acier inox - 4 échelles
 Setzer-Maßstab aus rostfreiem Stahl - 4 Skalen
 Tipometro acero inox - 4 escalas



Su richiesta disponibili in
 differenti misure e graduazioni

On demande, different sizes and graduations available
 A demanda hay otras medidas y graduaciones
 Sur demande d'autres longueurs
 et graduations sont disponibles
 Auf Anfrage sind andere Längen
 und Teilungen verfügbar

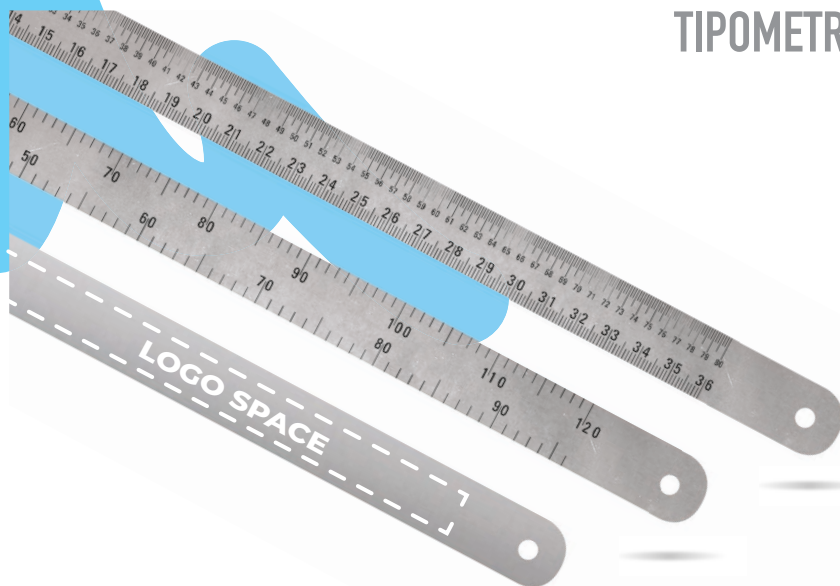

Ref.	LxHxP			H x L
24123	360 x 20 x 0,5 mm/pti	8001066241231	1	36 x 220 mm

Stampa diretta massimo 1 colore - Direct printing maximum 1 color - Impression directe en 1 couleur maximum - Direktdruck maximal 1 Farbe - Impresión directa a 1 color como máximo
 oppure - or - ou - oder - o

Incisione laser - Laser printing - Impresión láser - Laserdruck - Impression laser

RIGHE ACCIAIO INOX 30 X 1 MM

Righe in acciaio inox semi rigide
 Stainless steel semi-stiff rule
 Reglet semirigide en acier inox
 Halbstarrer Maßstab aus rostfreiem Stahl
 Regla de acero inox semi-rigido



Su richiesta disponibili in
 differenti misure e graduazioni

On demande, different sizes and graduations available
 A demanda hay otras medidas y graduaciones
 Sur demande d'autres longueurs
 et graduations sont disponibles
 Auf Anfrage sind andere Längen
 und Teilungen verfügbar

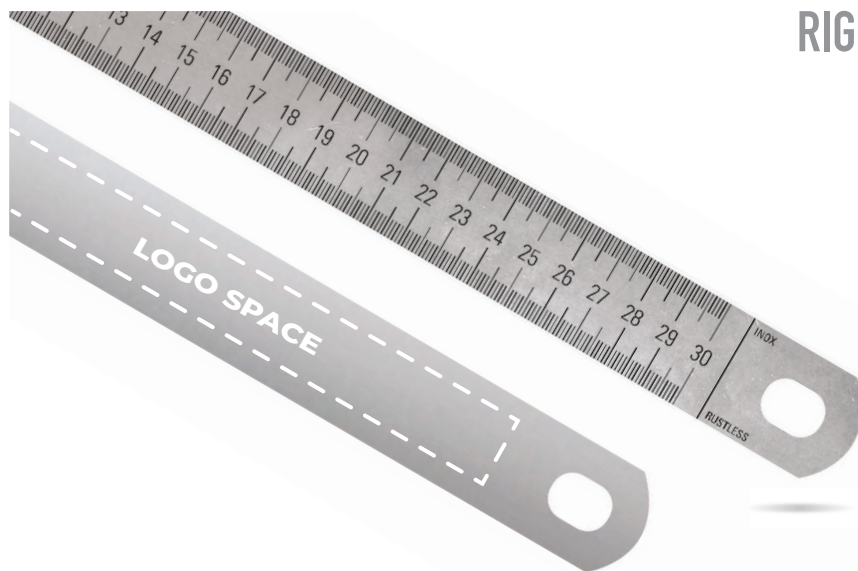

Ref.	LxHxP			H x L
25101	200 x 30 x 1 mm	8001066251018	1	15 x 220 mm
25102	500 x 30 x 1 mm	8001066251025	1	15 x 220 mm
25121	300 x 30 x 1 mm	8001066251216	1	15 x 220 mm
25122	500 x 30 x 1 mm/1/2mm	8001066251223	1	15 x 220 mm

Stampa diretta massimo 1 colore - Direct printing maximum 1 color - Impression directe en 1 couleur maximum - Direktdruck maximal 1 Farbe - Impresión directa a 1 color como máximo
 oppure - or - ou - oder - o

Incisione laser - Laser printing - Impresión láser - Laserdruck - Impression laser

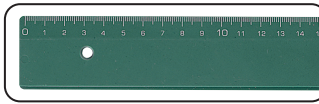
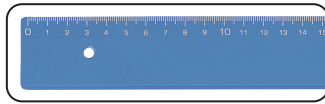
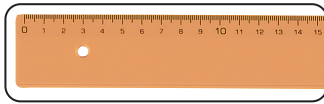

RIGHELLI IN PLASTICA

Righelli in plastica, plastic rule, règles en plastique, Kunststoff-Lineale, reglas de plástico



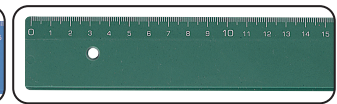
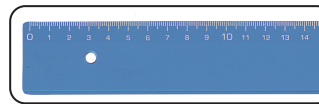
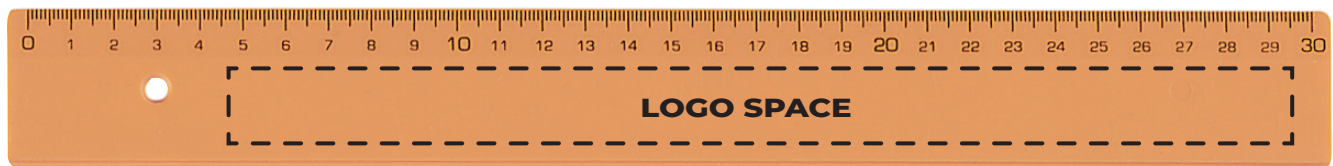

Ref.	LxHxP			H x L	
25395 ○	300 x 38 x 2,8 mm	8001066253951	1	15 x 220 mm	Stampa diretta massimo 1 colore - Direct printing maximum 1 color - Impression directe en 1 couleur maximum - Direktdruck maximal 1 Farbe - Impresión directa a 1 color como máximo
25396 ●	300 x 38 x 2,8 mm	8001066253968	1	15 x 220 mm	
25398 ●	300 x 38 x 2,8 mm	8001066253982	1	15 x 220 mm	
25399 ●	300 x 38 x 2,8 mm	8001066253999	1	15 x 220 mm	
25400 ●	300 x 38 x 2,8 mm	8001066254002	1	15 x 220 mm	

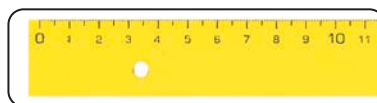
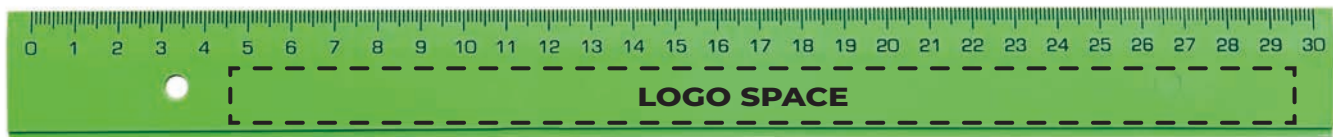

Ref.	LxHxP			H x L	
25410 ○	300 x 30 x 2,5 mm	8001066254101	1	14 x 210 mm	Stampa diretta massimo 1 colore - Direct printing maximum 1 color - Impression directe en 1 couleur maximum - Direktdruck maximal 1 Farbe - Impresión directa a 1 color como máximo
25411 ●	300 x 30 x 2,5 mm	8001066254118	1	15 x 220 mm	
25413 ●	300 x 30 x 2,5 mm	8001066254132	1	15 x 220 mm	
25414 ●	300 x 30 x 2,5 mm	8001066254149	1	15 x 220 mm	
25415 ●	300 x 30 x 2,5 mm	8001066254156	1	15 x 220 mm	



Ref.	LxHxP			H x L	
25450 ●	300 x 30 x 2,5 mm	8001066254507	1	11 x 195 mm	Stampa diretta massimo 1 colore - Direct printing maximum 1 color - Impression directe en 1 couleur maximum - Direktdruck maximal 1 Farbe - Impresión directa a 1 color como máximo
25451 ●	300 x 30 x 2,5 mm	8001066254514	1	11 x 195 mm	
25452 ●	300 x 30 x 2,5 mm	8001066254521	1	11 x 195 mm	

SCALIMETRO IN METALLO

Scalimetro in metallo, **5 scale, 30 cm**
 3-sided rule, **5 scales, 30 cm**
 Règle cutch 3 cotés, **5 échelles, 30 cm**
 3-Kant-Lineal, **5 Teilungen, 30 cm**
 Regla 3 lados, **5 escalas, 30 cm**

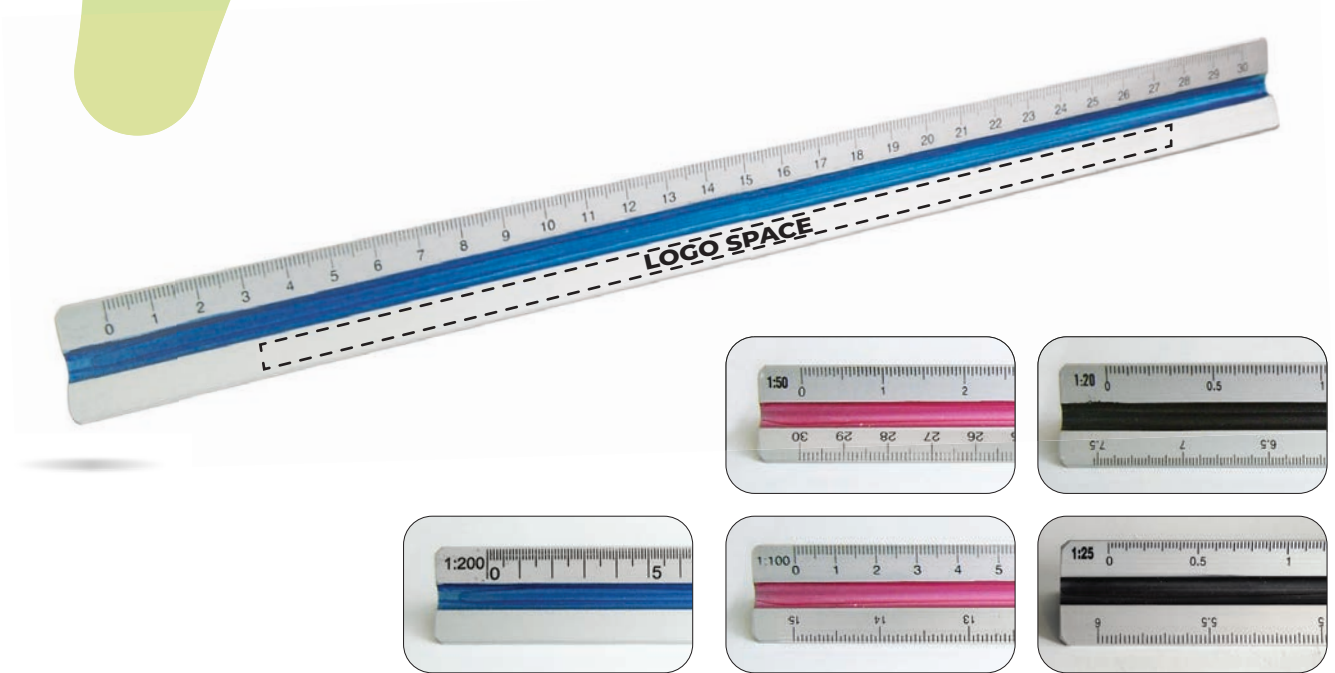

Ref.	L			H x L
60186M	30 cm	8001066601868	1	4 x 150 mm <i>Stampa diretta massimo 1 colore - Direct printing maximum 1 color - Impression directe en 1 couleur maximum - Direktdruck maximal 1 Farbe - Impresión directa a 1 color como máximo</i>

RIGHELLO A VENTAGLIO

Righello a ventaglio **6 in 1**
 Fan-type rule **6 in 1**
 Règles en éventail **6 en 1**
 Fächer-Maßstab **6 in 1**
 Regla abanico **6 en 1**

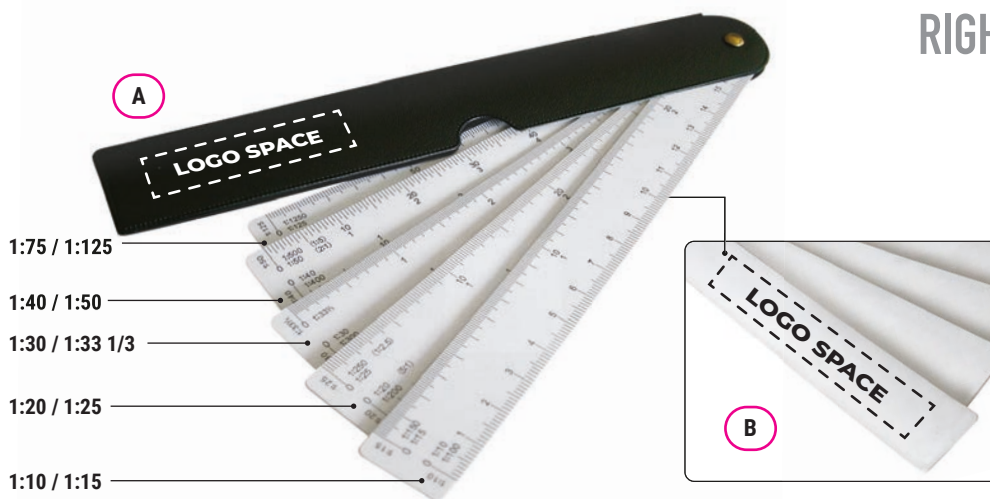

Ref.				H x L
25391	16 cm	8001066253913	1	A 15 x 90 mm B 12 x 120 mm <i>Stampa diretta massimo 1 colore - Direct printing maximum 1 color - Impression directe en 1 couleur maximum - Direktdruck maximal 1 Farbe - Impresión directa a 1 color como máximo</i>



FINGERSAFE

Battichiodo **magnetico salvadito** per chiodi piccoli e grandi

Magnetic nail holder for small and large nails

Porte-clou aimanté pour petits et grands clous

Fingerschutz-Nagelhalter für kleine und große Nägel

Portauñas magnético

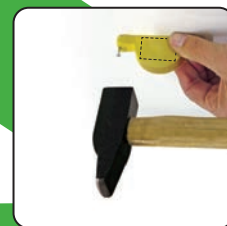
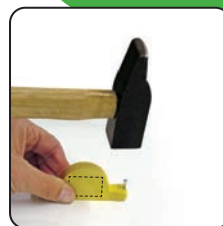
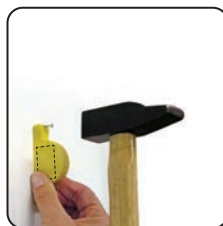
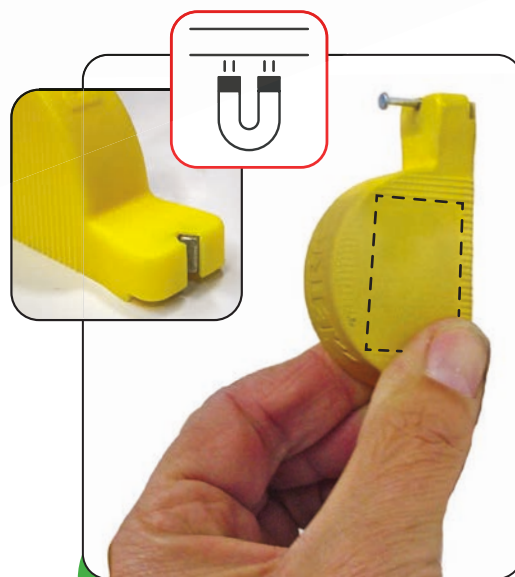

Ref.



H x L

69997N ●
69997BN ●

8001066699971
8001066689477

12
12

21 x 35 mm
21 x 35 mm

Stampa su etichetta in quadricromia

Four-colour label printing - Impression en quadrichromie sur étiquettes - Vierfarbendruck auf Etiketten - Impresión de la etiqueta en cuatricromía

NEW



METRICA MINI ALU 30

Misuratore laser 30 m
 Distancemeter 30 m
 Télémètre laser 30 m
 Laser-Entfernungsmesser 30 m
 Medidor láser 30 m



Ref.				
61660	30 m	85 x 22 x 10 mm	8001066616602	1

H x L

75 x 5 mm

Stampa su etichetta in quadricromia
 Four-colour label printing - Impression en quadrichromie sur étiquettes - Vierfarbendruck auf Etiketten - Impresión de la etiqueta en cuatricromía



METRICA FLASH **DOUBLE LASER**

Misuratore laser 50m
 Distancemeter 50m
 Télémètre laser 50m
 Laser-Entfernungsmesser 50m
 Medidor láser 50m

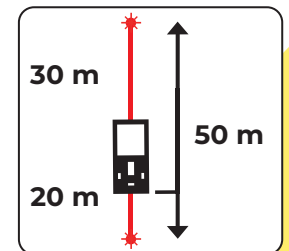

Ref.				
61114	50 m	85 x 38 x 20 mm	8001066611140	1

H x L

30 x 20 mm

Stampa su etichetta in quadricromia
 Four-colour label printing - Impression en quadrichromie sur étiquettes - Vierfarbendruck auf Etiketten - Impresión de la etiqueta en cuatricromía

oppure - or - ou - oder - o

Stampa diretta massimo 1 colore - Direct printing maximum 1 color - Impression directe en 1 couleur maximum - Direktdruck maximal 1 Farbe - Impresión directa a 1 color como máximo



FLASH MINI30

Misuratore laser 30 m
 Distancemeter 30 m
 Télémètre laser 30 m
 Laser-Entfernungsmesser 30 m
 Medidor láser 30 m

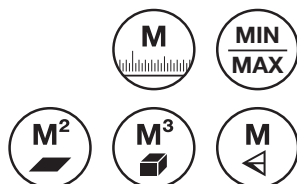

Ref.					H x L
61110	30 m	74 x 34 x 15 mm	8001066611102	1	50 x 8 mm
					<p>Stampa su etichetta in quadricromia <i>Four-colour label printing - Impression en quadrichromie sur étiquettes - Vierfarbendruck auf Etiketten - Impresión de la etiqueta en cuatricromía</i> oppure - or - ou - oder - o</p> <p>Stampa diretta massimo 1 colore - Direct printing maximum 1 color - Impression directe en 1 couleur maximum - Direktdruck maximal 1 Farbe - Impresión directa a 1 color como máximo</p>



FLASH GO 15

Misuratore laser 15m
 Distancemeter 15m
 Télémètre laser 15m
 Laser-Entfernungsmesser 15m
 Medidor láser 15m



Ref.					H x L
61109	15 m	75 x 37 x 14 mm	8001066611096	1	10 x 30 mm
					<p>Stampa su etichetta in quadricromia <i>Four-colour label printing - Impression en quadrichromie sur étiquettes - Vierfarbendruck auf Etiketten - Impresión de la etiqueta en cuatricromía</i> oppure - or - ou - oder - o</p> <p>Stampa diretta massimo 1 colore - Direct printing maximum 1 color - Impression directe en 1 couleur maximum - Direktdruck maximal 1 Farbe - Impresión directa a 1 color como máximo</p>

NEW



METRICA ALU 60

Misuratore laser 60 m, corpo in alluminio
 Distancemeter 60 m, aluminum body
 Télémètre laser 60 m, boîtier en aluminium
 Laser-Entfernungsmesser 60 m, Aluminiumgehäuse
 Medidor láser 60 m, cuerpo de aluminio

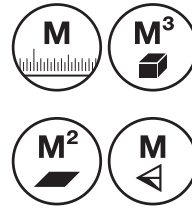

Ref.					H x L
61661	60 m	100 x 34 x 18 mm	8001066616619	1	80 x 8 mm

Stampa su etichetta in quadricromia
 Four-colour label printing - Impression en quadrichromie sur étiquettes - Vierfarbendruck auf Etiketten - Impresión de la etiqueta en cuatricromía

NEW



METRICA GO 40

Misuratore laser 40 m
 Distancemeter 40 m
 Télémètre laser 40 m
 Laser-Entfernungsmesser 40 m
 Medidor láser 40 m



Ref.					H x L
61134	40 m	104 x 43 x 26 mm	8001066611348	1	17 x 37 mm

Stampa su etichetta in quadricromia
 Four-colour label printing - Impression en quadrichromie sur étiquettes - Vierfarbendruck auf Etiketten - Impresión de la etiqueta en cuatricromía



Metrica S.p.A. - Italy
Via Grandi, 18 - 20097 San Donato

METRICA.IT - [@METRICA.IT](https://www.instagram.com/METRICA.IT) - [YOUTUBE](https://www.youtube.com/METRICA.IT)